

INSTALLATION AND OWNER'S MANUAL

Optimus Pro split
Indoor unit

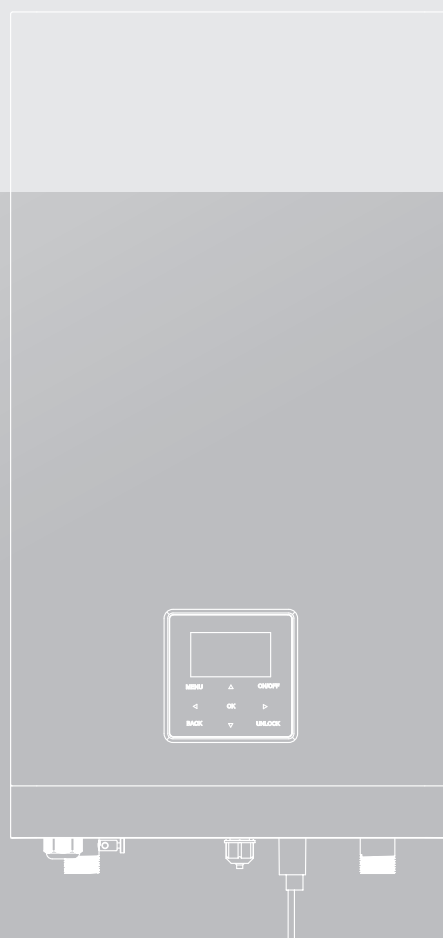

IMPORTANT NOTE:



Thank you very much for purchasing our product,
Before using your unit , please read this manual carefully and keep it for future reference.

CONTENTS

1 SAFETY PRECAUTIONS	02
2 BEFORE INSTALLATION	08
3 INSTALLATION SITE	08
4 INSTALLATION PRECAUTIONS	10
• 4.1 Dimensions	10
• 4.2 Installation requirements	10
• 4.3 Servicing space requirements	11
• 4.4 Mounting the indoor unit	12
• 4.5 Refrigerant pipe connection	12
5 GENERAL INTRODUCTION	13
6 ACCESSORIES	14
7 TYPICAL APPLICATIONS	15
• 7.1 Application 1	15
• 7.2 Application 2	17
8 OVERVIEW OF THE UNIT	21
• 8.1 Disassembling the unit	21
• 8.2 Main components	21
• 8.3 Electronic control box	23
• 8.4 Refrigerant pipework	25
• 8.5 Water piping	25
• 8.6 Filling water	29
• 8.7 Water piping insulation	30
• 8.8 Field wiring	30
9 START-UP AND CONFIGURATION	42
• 9.1 DIP switch settings overview	42
• 9.2 Initial start-up at low outdoor ambient temperature	43
• 9.3 Pre-operation checks	43
• 9.4 Setting the pump	44
• 9.5 Field settings	46
10 TEST RUN AND FINAL CHECKS	57
• 10.1 Final checks	57
• 10.2 Test run operation (manually)	57

11	MAINTENANCE AND SERVICE	57
12	TROUBLE SHOOTING	58
	• 12.1 General guidelines	58
	• 12.2 General symptoms	58
	• 12.3 Operation parameter	60
	• 12.4 Error codes	62
13	TECHNICAL SPECIFICATIONS	65
14	INFORMATION SERVICING	67

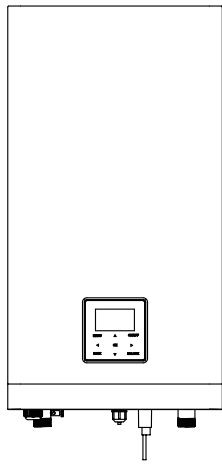

Basic

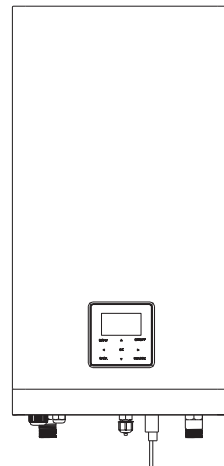

Customized

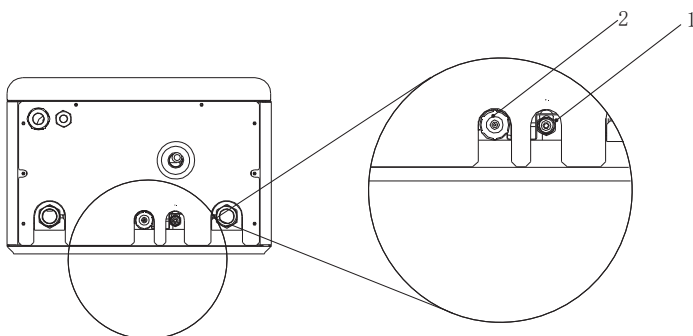
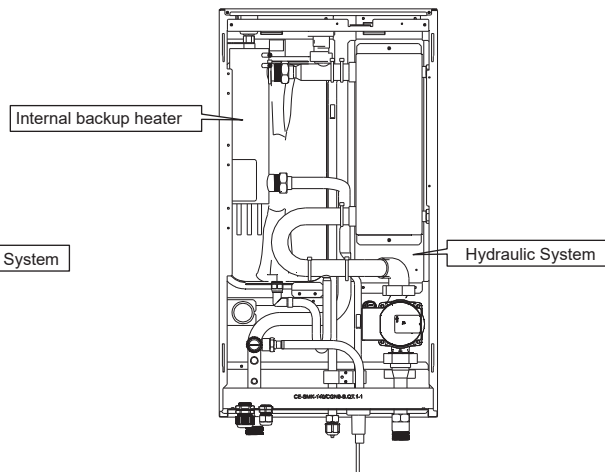
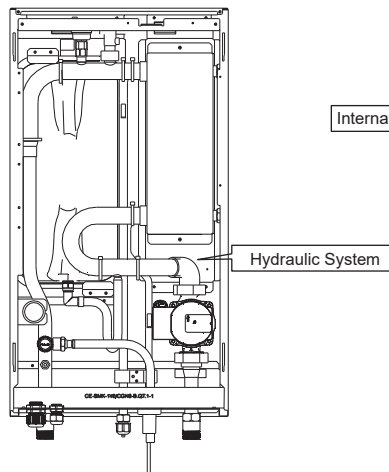
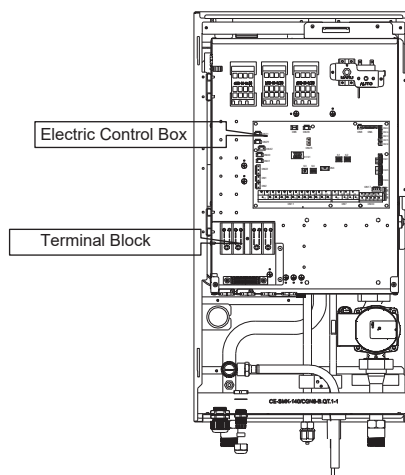
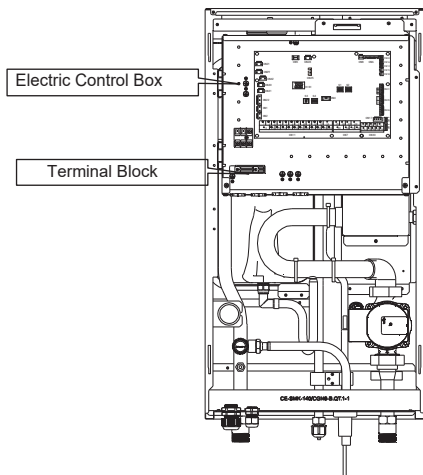

Unit	Diameter(mm)	
	1	2
60	6.35	15.9
100	9.52	15.9
160	9.52	15.9

1 SAFETY PRECAUTIONS

The precautions listed here are divided into the following types. They are quite important, so be sure to follow them carefully. Read these instructions carefully before installation. Keep this manual in a handy for future reference.

Meanings of DANGER, WARNING, CAUTION and NOTE symbols.

DANGER

Indicates an imminently hazardous situation which if not avoided, will result in death or serious injury.

WARNING

Indicates a potentially hazardous situation which if not avoided, could result in death or serious injury.

CAUTION

Indicates a potentially hazardous situation which if not avoided, may result in minor or moderate injury. It is also used to alert against unsafe practices.

NOTE

Indicates situations that could only result in accidental equipment or property damage.

WARNING

- Improper installation of equipment or accessories may result in electric shock, short-circuit, leakage, fire or other damage to the equipment. Be sure to only use accessories made by the supplier, which are specifically designed for the equipment and make sure to get installation done by a certified person.
- All the activities described in this manual must be carried out by a licensed technician. Be sure to wear adequate personal protection equipment such as gloves and safety glasses while installing the unit or carrying out maintenance activities.



Caution: Risk of fire/
flammable materials

WARNING

Servicing shall only be performed as recommended by the equipment manufacturer. Maintenance and repair requiring the assistance of other skilled personnel shall be carried out under the supervision of the person competent in the use of flammable refrigerants.

Special requirements for R32

⚠ WARNING

- Do NOT have refrigerant leakage and open flame.
- Be aware that the R32 refrigerant does NOT contain an odour.

⚠ WARNING

The appliance shall be stored so as to prevent mechanical damage and in a well-ventilated room without continuously operating ignition sources (example: open flames, an operating gas appliance) and have a room size as specified below.

💡 NOTE

- Do NOT re-use joints which have been used already.
- Joints made in installation between parts of refrigerant system shall be accessible for maintenance purposes.

⚠ WARNING

Make sure installation, servicing, maintenance and repair comply with instructions and with applicable legislation (for example national gas regulation) and are executed only by authorised persons.

💡 NOTE

- Pipework should be protected from physical damage.
- Installation of pipework shall be kept to a minimum length.

If the total refrigerant charge in the system is <1.84 kg (i.e. if the piping length is <20 m for 8/10kW), there are no additional minimum floor area requirements.

If the total refrigerant charge in the system is ≥ 1.84 kg (i.e. if the piping length is ≥ 20 m for 8/10kW), you need to comply with additional minimum floor area requirements as described in the following flow chart. The flow chart uses the following tables: "Table 1-Maximum refrigerant charge allowed in a room: indoor unit" on page 5, "Table 2-Minimum floor area: indoor unit" on page 5 and "Table 3-Minimum venting opening area for natural ventilation: indoor unit" on page 5.

If the piping length is 30m, then the minimum floor area is ≥ 4.5 m²; if the floor area is less than 4.5 m², it needs to be trepanned with a hole of 200 cm².

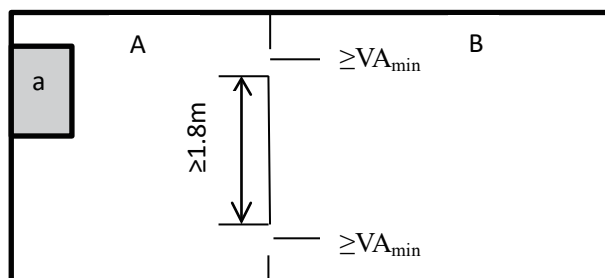

a Indoor unit

A Room where the indoor unit is installed.

B Room adjacent to room A.

The area of A plus B has to be greater than or equal to 4.5 m².

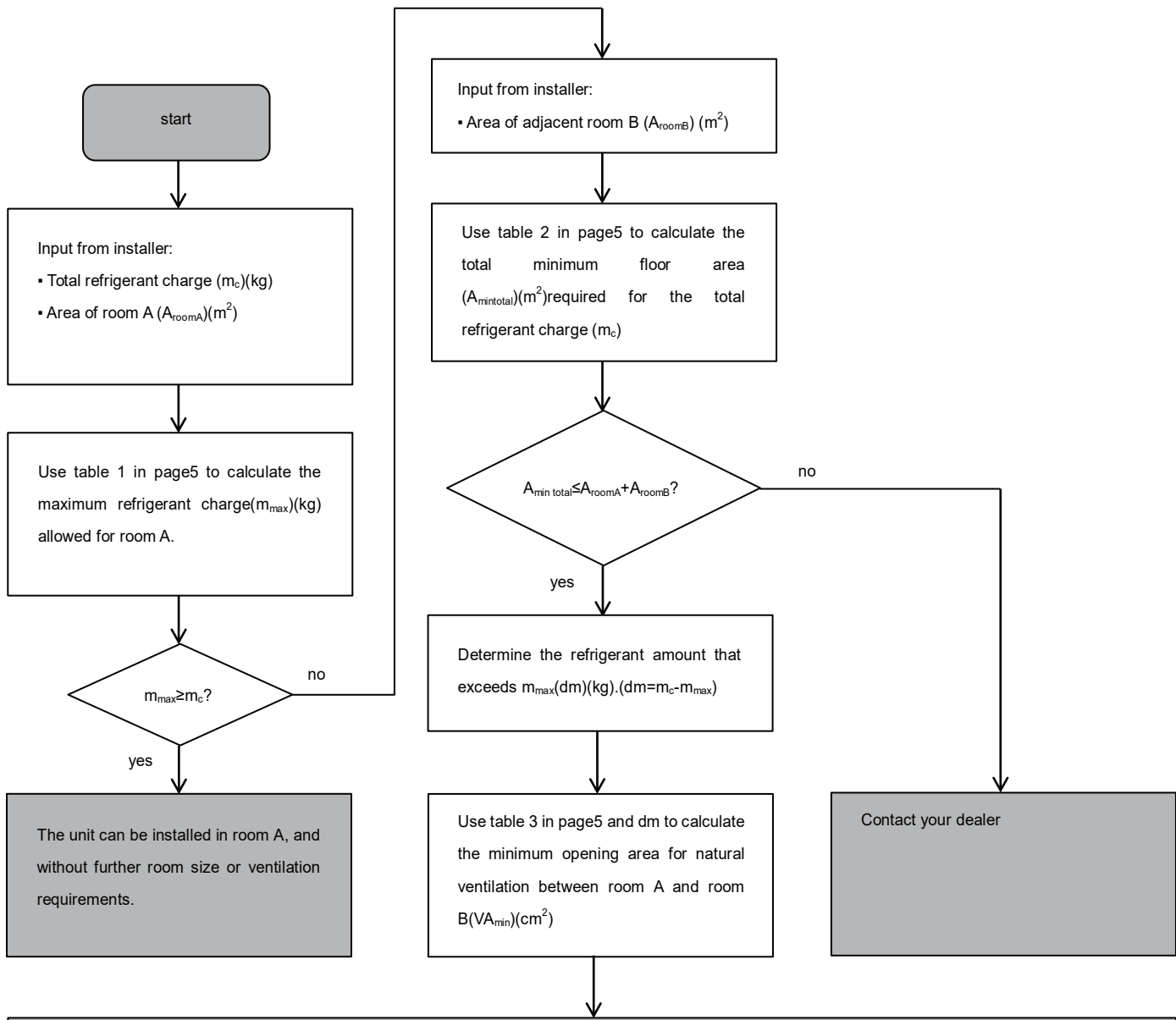

Unit can be installed at room A if:

- 2 ventilation openings (permanently open) are provided between room A and B, 1 at the top and 1 at the bottom.
- Bottom opening: The bottom opening must meet the minimum area requirements (VA_{min}). It must be as close as possible to the floor. If the ventilation opening starts from the floor, the height must be ≥ 20 mm. The bottom of the opening must be situated ≤ 100 mm from the floor. At least 50% of the required opening area must be situated < 200 mm from the floor. The entire area of the opening must be situated < 300 mm from the floor.
- Top opening: The area of the top opening must be larger than or equal to the bottom opening. The bottom of the top opening must be situated at least 1.5 m above the top of the bottom opening.
- Ventilation openings to the outside are NOT considered suitable ventilation openings (the user can block them when it is cold).

Table 1-Maximum refrigerant charge allowed in a room:indoor unit

A _{room} (m ²)	Maximum refrigerant charge in a room(m _{max})(kg)	A _{room} (m ²)	Maximum refrigerant charge in a room(m _{max})(kg)
	H=1800mm		
1	1.02	4	2.05
2	1.45	5	2.29
3	1.77	6	2.51

NOTE

- For wall mounted models, the value of "Installation height (H)" is considered 1800 mm to comply to IEC 60335-2-40:2013 A1 2016 Clause GG2.
- For intermediate A_{room} values(i.e. when A_{room} is between two values from the table), consider the value that corresponds to the lower A_{room} value from the table. If A_{room}=3m², consider the value that corresponds to "A_{room}=3m²".

Table 2-Minimum floor area:indoor unit

m _c (kg)	Minimum floor area(m ²)
	H=1800mm
1.84	3.32
2.00	3.81
2.25	4.83
2.50	5.96

NOTE

- For wall mounted models, the value of "Installation height (H)" is considered 1800 mm to comply to IEC 60335-2-40:2013 A1 2016 Clause GG2.
 - For intermediate m_c values(i.e. when m_c is between two values from the table), consider the value that corresponds to the higher m_c value from the table. If m_c=1.87kg, consider the value that corresponds to "m_c=1.87kg".
- Systems with total refrigerant charge lower than 1.84kg are not subjected to any room requirements.

Table 3-Minimum venting opening area for natural ventilation: indoor unit

m _c	m _{max}	dm=m _c -m _{max} (kg)	Minimum venting opening area(cm ²)
			H=1800mm
2.22	0.1	2.12	495.14
2.22	0.3	1.92	448.43
2.22	0.5	1.72	401.72
2.22	0.7	1.52	355.01
2.22	0.9	1.32	308.30
2.22	1.1	1.12	261.59
2.22	1.3	0.92	214.87
2.22	1.5	0.72	168.16
2.22	1.7	0.52	121.45
2.22	1.9	0.32	74.74
2.22	2.1	0.12	28.03

NOTE

- For wall mounted models, the value of "Installation height (H)" is considered 1800 mm to comply to IEC 60335-2-40:2013 A1 2016 Clause GG2.
- For intermediate dm values(i.e. when dm is between two values from the table), consider the value that corresponds to the higher dm value from the table. If dm =1.55kg, consider the value that corresponds to "dm =1.6kg".

DANGER

- Before touching electric terminal parts, turn off power switch.
- When service panels are removed, live parts can be easily touched by accident.
- Never leave the unit unattended during installation or servicing when the service panel is removed.
- Do not touch water pipes during and immediately after operation as the pipes may be hot and could burn your hands. To avoid injury, give the piping time to return to normal temperature or be sure to wear protective gloves.
- Do not touch any switch with wet fingers. Touching a switch with wet fingers can cause electrical shock.
- Before touching electrical parts, turn off all applicable power to the unit.

WARNING

- Tear apart and throw away plastic packaging bags so that children will not play with them. Children playing with plastic bags face danger of death by suffocation.
- Safely dispose of packing materials such as nails and other metal or wood parts that could cause injuries.
- Ask your dealer or qualified personnel to perform installation work in accordance with this manual. Do not install the unit by yourself. Improper installation could result in water leakage, electric shocks or fire
- Be sure to use only specified accessories and parts for installation work. Failure to use specified parts may result in water leakage, electric shocks, fire, or the unit falling from its mount.
- Install the unit on a foundation that can withstand its weight. Insufficient physical strength may cause the equipment to fall and possible injury.
- Perform specified installation work with full consideration of strong wind, hurricanes, or earthquakes. Improper installation work may result in accidents due to equipment falling.
- Make certain that all electrical work is carried out by qualified personnel according to the local laws and regulations and this manual using a separate circuit. Insufficient capacity of the power supply circuit or improper electrical construction may lead to electric shocks or fire.
- Be sure to install a ground fault circuit interrupter according to local laws and regulations. Failure to install a ground fault circuit interrupter may cause electric shocks and fire.
- Make sure all wiring is secure. Use the specified wires and ensure that terminal connections or wires are protected from water and other adverse external forces. Incomplete connection or affixing may cause a fire.
- When wiring the power supply, form the wires so that the front panel can be securely fastened. If the front panel is not in place there could be overheating of the terminals, electric shocks or fire.
- After completing the installation work, check to make sure that there is no refrigerant leakage.
- Never directly touch any leaking refrigerant as it could cause severe frostbite. Do not touch the refrigerant pipes during and immediately after operation as the refrigerant pipes may be hot or cold, depending on the condition of the refrigerant flowing through the refrigerant piping, compressor and other refrigerant cycle parts. Burns or frostbite are possible if you touch the refrigerant pipes. To avoid injury, give the pipes time to return to normal temperature or, if you must touch them, be sure to wear protective gloves.
- Do not touch the internal parts (pump, backup heater, etc.) during and immediately after operation. Touching the internal parts can cause burns. To avoid injury, give the internal parts time to return to normal temperature or, if you must touch them, be sure to wear protective gloves.

CAUTION

- Ground the unit.
- Grounding resistance should be according to local laws and regulations.
- Do not connect the ground wire to gas or water pipes, lightning conductors or telephone ground wires.
- Incomplete grounding may cause electric shocks.
 - Gas pipes: Fire or an explosion might occur if the gas leaks.
 - Water pipes: Hard vinyl tubes are not effective grounds.
 - Lightning conductors or telephone ground wires: Electrical threshold may rise abnormally if struck by a lightning bolt.

CAUTION

- Install the power wire at least 3 feet (1 meter) away from televisions or radios to prevent interference or noise. (Depending on the radio waves, a distance of 3 feet (1 meter) may not be sufficient to eliminate the noise.)
- Do not wash the unit. This may cause electric shocks or fire. The appliance must be installed in accordance with national wiring regulations. If the supply cord is damaged, it must be replaced by the manufacturer, its service agent or similarly qualified persons in order to avoid a hazard.
- Do not install the unit in the following places:
 - Where there is mist of mineral oil, oil spray or vapors. Plastic parts may deteriorate, and cause them to come loose or water to leak.
 - Where corrosive gases (such as sulphurous acid gas) are produced. Where corrosion of copper pipes or soldered parts may cause refrigerant to leak.
 - Where there is machinery which emits electromagnetic waves. Electromagnetic waves can disturb the control system and cause equipment malfunction.
 - Where flammable gases may leak, where carbon fiber or ignitable dust is suspended in the air or where volatile flammables such as paint thinner or gasoline are handled. These types of gases might cause a fire.
 - Where the air contains high levels of salt such as near the ocean.
 - Where voltage fluctuates a lot, such as in factories.
 - In vehicles or vessels.
 - Where acidic or alkaline vapors are present.
- This appliance can be used by children 8 years old and above and persons with reduced physical, sensory or mental capabilities or lack of experience and knowledge if they are supervised or given instruction on using the unit in a safe manner and understand the hazards involved. Children should not play with the unit. Cleaning and user maintenance should not be done by children without supervision.
- Children should be supervised to ensure that they do not play with the appliance.

If the supply cord is damaged, it must be replaced by the manufacturer or its service agent or a similarly qualified person.
- **DISPOSAL:** Do not dispose this product as unsorted municipal waste. Collection of such waste separately for special treatment is necessary. Do not dispose of electrical appliances as municipal waste, use separate collection facilities. Contact your local government for information regarding the collection systems available. If electrical appliances are disposed of in landfills or dumps, hazardous substance can leak into the groundwater and get into the food chain, damaging your health and well-being.
- The wiring must be performed by certified person technicians in accordance with national wiring regulation and this circuit diagram. An all-pole disconnection device which has at least 3mm separation distance in all pole and a residual current device (RCD) with the rating not exceeding 30mA shall be incorporated in the fixed wiring according to the national rule.
- Confirm the safety of the installation area (walls, floors, etc.) without hidden dangers such as water, electricity, and gas before wiring/pipes.
- Before installation , check whether the user's power supply meets the electrical installation requirements of unit (including reliable grounding , leakage , and wire diameter electrical load, etc.). If the electrical installation requirements of the product are not met, the installation of the product is prohibited until the product is rectified.
- Product installation should be fixed firmly, Take reinforcement measures, when necessary.

NOTE

- **About Fluorinated Gases**
 - This air-conditioning unit contains fluorinated gases. For specific information on the type of gas and the amount, please refer to the relevant label on the unit itself. Compliance with national gas regulations shall be observed.
 - Installation, service, maintenance and repair of this unit must be performed by a certified technician.
 - Product uninstallation and recycling must be performed by a certified technician.
 - If the system has a leak-detection system installed, it must be checked for leaks at least every 12 months. When the unit is checked for leaks, proper record-keeping of all checks is strongly recommended.

2 BEFORE INSTALLATION

- **Before installation**

Be sure to confirm the model name and the serial number of the unit.

CAUTION

Frequency of Refrigerant Leakage Checks

- For unit that contains fluorinated greenhouse gases in quantities of 5 tonnes of CO₂ equivalent or more, but of less than 50 tonnes of CO₂ equivalent, at least every 12 months, or where a leakage detection system is installed, at least every 24 months.
- For unit that contains fluorinated greenhouse gases in quantities of 50 tonnes of CO₂ equivalent or more, but of less than 500 tonnes of CO₂ equivalent at least every six months, or where a leakage detection system is installed, at least every 12 months.
- For unit that contains fluorinated greenhouse gases in quantities of 500 tonnes of CO₂ equivalent or more, at least every three months, or where a leakage detection system is installed, at least every six months.
- This air-conditioning unit is a hermetically sealed equipment that contains fluorinated greenhouse gases.
- Only certificated person is allowed to do installation, operation and maintenance.

3 INSTALLATION SITE

WARNING

- There is flammable refrigerant in the unit and it should be installed in a well-ventilated site. If the unit is installed inside, an additional refrigerant detection device and ventilation equipment must be added in accordance with the standard EN378. Be sure to adopt adequate measures to prevent the unit from being used as a shelter by small animals.
 - Small animals making contact with electrical parts can cause malfunction, smoke or fire. Please instruct the customer to keep the area around the unit clean.
 - The equipment is not intended for use in a potentially explosive atmosphere.
-
- Select an installation site where the following conditions are satisfied and one that meets with your customer's approval.
 - Places that are well-ventilated.
 - Safe places which can bear the unit's weight and vibration and where the unit can be installed at an even level.
 - Places where there is no possibility of flammable gas or product leak.
 - The equipment is not intended for use in a potentially explosive atmosphere.
 - Places where servicing space can be well ensured.
 - Places where the units' piping and wiring lengths come within the allowable ranges.
 - Places where water leaking from the unit cannot cause damage to the location (e.g. in case of a blocked drain pipe).
 - Do not install the unit in places often used as a work space. In case of construction work (e.g. grinding etc.) where a lot of dust is created, the unit must be covered.
 - Do not place any object or equipment on top of the unit (top plate)
 - Do not climb, sit or stand on top of the unit.
 - Be sure that sufficient precautions are taken in case of refrigerant leakage according to relevant local laws and regulations.

 **CAUTION**

The indoor unit should be installed in an indoor water proof place, or the safety of the unit and the operator cannot be ensured.

The indoor unit is to be wall mounted in an indoor location that meets the following requirements:

- The installation location is frost-free.
- The space around the unit is adequate for serving, see figure 4-4.
- The space around the unit allows for sufficient air circulation.
- There is a provision for condensate drain and pressure relief valve blow-off.

 **CAUTION**

When the unit running in the cooling mode, condensate may drop from the water inlet and water outlet pipes. Please make sure the dropping condensate will not result in damage of your furniture and other devices.

- The installation surface is a flat and vertical non-combustible wall, capable of supporting the operation weight of the unit.
- All piping lengths and distance have been taken into consideration.

Table 3-1

Requirement	Value
Maximum allowable piping length between the 3-way valve SV1 and the indoor unit (only for installations with domestic hot water tank)	3m
Maximum allowable piping length between the domestic hot water tank and the indoor unit (only for installations with domestic hot water tank). The temperature sensor cable supplied with the indoor unit is 10m in length.	8m
Maximum allowable piping length between the TW2 and the indoor unit. The temperature sensor a cable of TW2 supplied with the indoor unit is 10m in length.	8m

4 INSTALLATION PRECAUTIONS

4.1 Dimensions

Dimensions of the wall bracket:

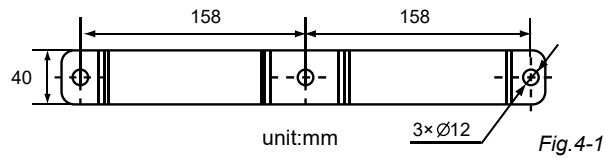

Dimensions of the unit:

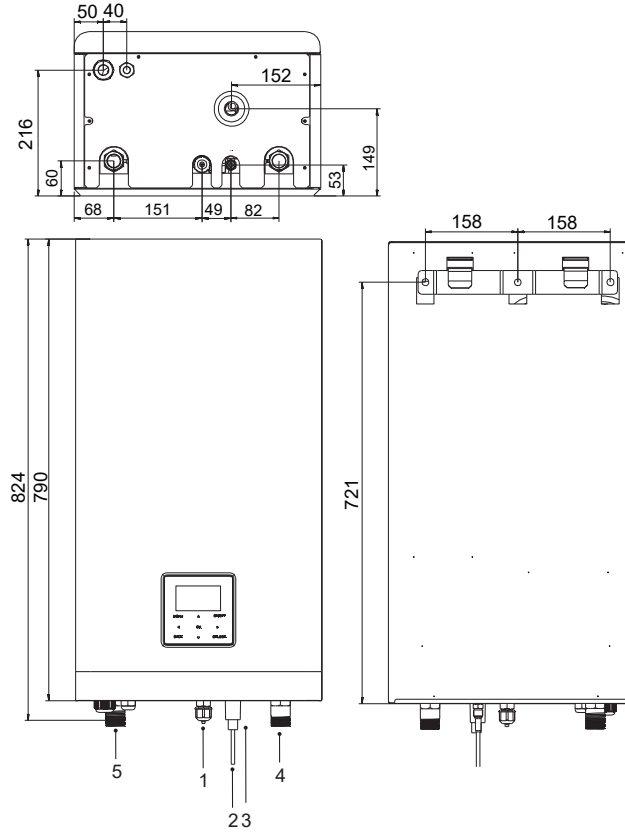

Fig.4-2

		unit:mm
NO.	NAME	
1	Refrigerant gas connection 5/8"-14UNF	
2	Refrigerant liquid connection 1/4"(60) or 3/8"(100/160) -14UNF	
3	Drainage Ø25	
4	Water Inlet R1"	
5	Water Outlet R1"	

4.2 Installation requirements

- The indoor unit is packed in a box.
- At delivery, the unit must be checked and any damage must be reported immediately to the carrier claims agent.
- Check if all indoor unit accessories are enclosed.
- Bring the unit as close as possible to the final installation position in its original package in order to prevent damage during transport.
- The indoor unit weight is approximately 50kg and should be lifted by two persons.

⚠ WARNING

Do not grasp the control box or pipe to lift the unit!

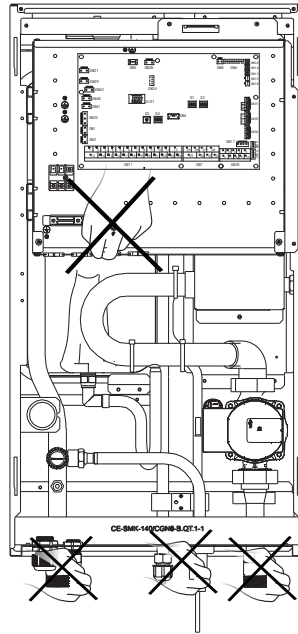
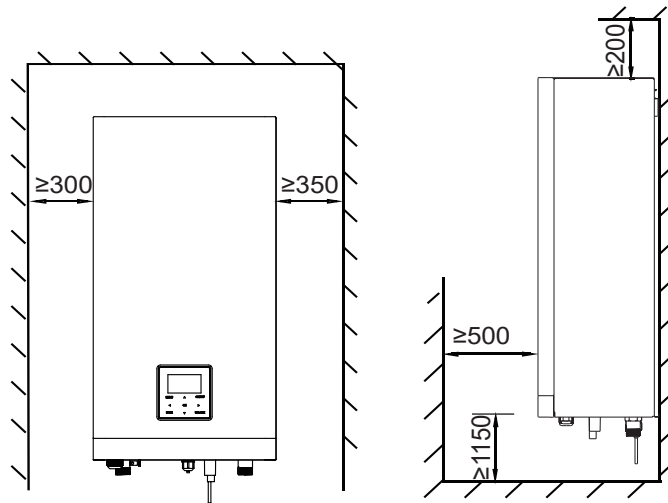

Fig.4-3

4.3 Servicing space requirements



unit:mm

Fig.4-4

4.4 Mounting the indoor unit

- Fix the wall mounting bracket to the wall using appropriate plugs and screws.
- Make sure the wall mounting bracket is horizontal level.
- Pay special attention to prevent overflow of the drain pan.
- Hang the indoor unit on the wall mounting bracket.

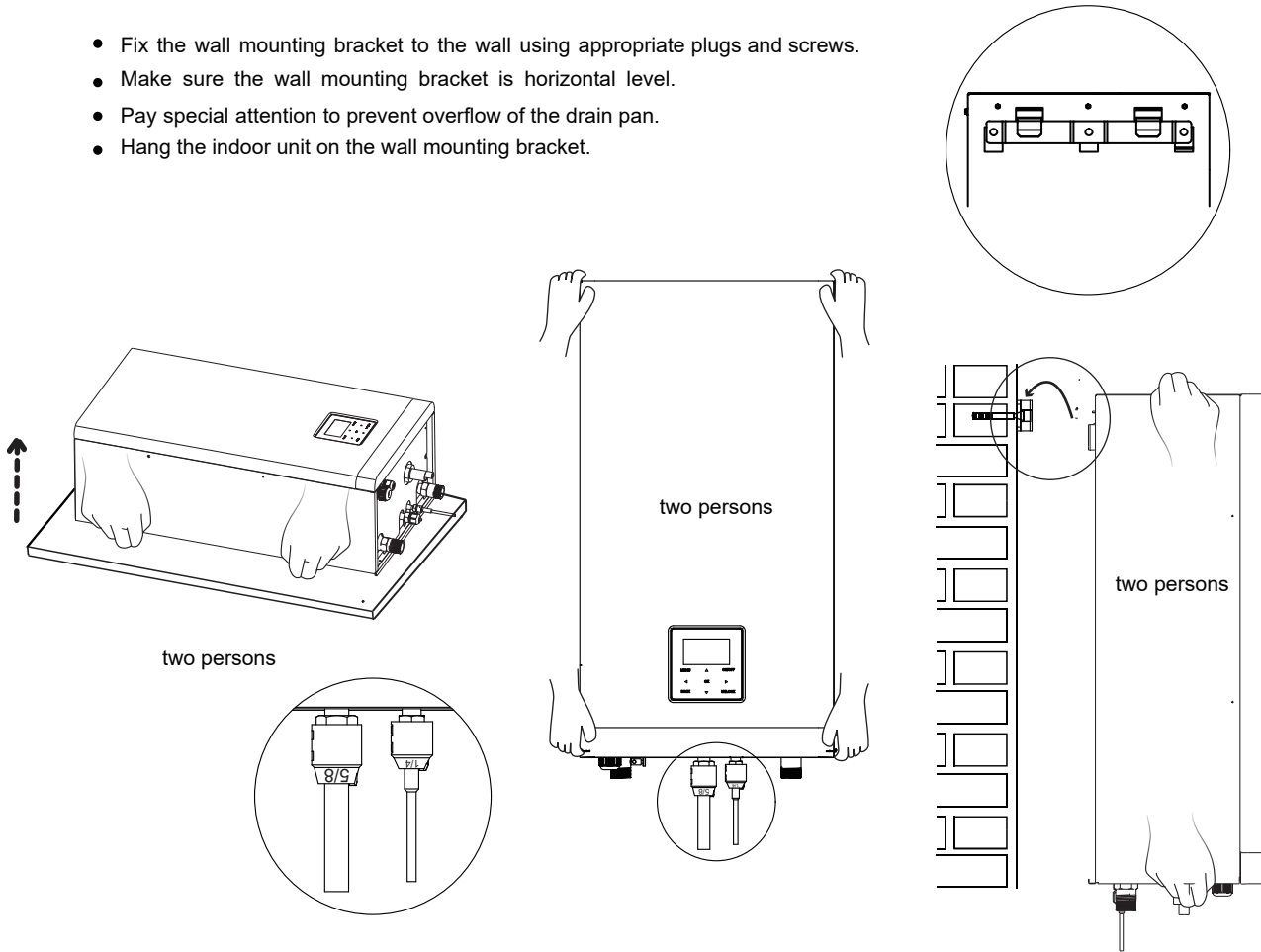
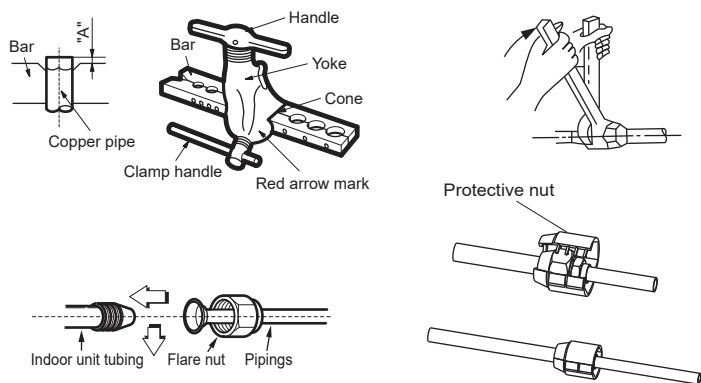

Fig.4-5

4.5 Refrigerant pipe connection

- Align the center of the pipes.
- Sufficiently tighten the flare nut with fingers, and then tighten it with a spanner and torque wrench .
- The protective nut is a one-time part, it can not be reused. In case it is removed, it should be replaced with a new one.

Outer diam.	Tightening torque(N.cm)	Additional tightening torque(N.cm)
φ 6.35	1500 (153kgf.cm)	1600 (163kgf.cm)
φ 9.52	2500 (255kgf.cm)	2600 (265kgf.cm)
φ 16	4500 (459kgf.cm)	4700 (479kgf.cm)



CAUTION

- Excessive torque can break nut on installation conditions.
- When flared joints are reused indoors, the flare part should be re-fabricated.

5 GENERAL INTRODUCTION

- These units are used for both heating and cooling applications and domestic hot water tanks. They can be combined with fan coil units, floor heating applications, low temperature high efficiency radiators, domestic hot water tanks (field supply) and solar kits (field supply).
- A wired controller is supplied with the unit .
- If you choose the built-in backup heater unit, the backup heater can increase the heating capacity during cold outdoor temperatures. The backup heater also serves as a backup in case of malfunctioning and for frozen protection of the outside water piping during winter time.

NOTE

- Maximum length of communication wirings between the indoor unit and the controller is 50m.
- Power cords and communication wiring must be laid out separately, they can not be placed in the same conduit. Otherwise, it may lead to electromagnetic interference. Power cords and communication wirings should not come in contact with the refrigerant pipe so as to prevent the high temperature pipe from damaging wirings.
- Communication wirings must use shielded lines. Including indoor unit to outdoor unit PQE line ,indoor unit to controller ABXYE line.

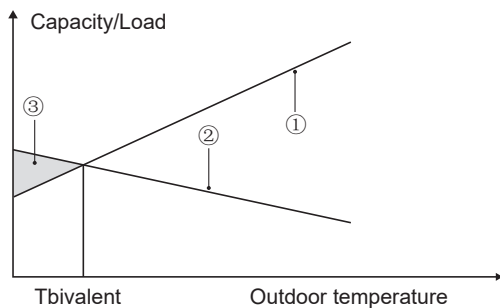

- ① Heat pump capacity.
- ② Required heating capacity (site dependent).
- ③ Additional heating capacity provided by backup heater.

Domestic hot water tank (field supply)

A domestic hot water tank(with or without booster heater) can be connected to the unit.

The requirement of the tank is different for different unit and material of heat exchanger.

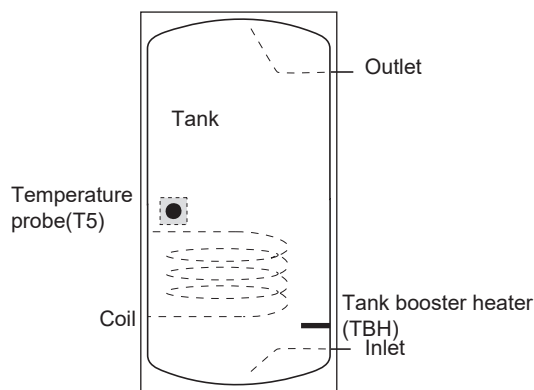

The booster heater should be installed below the temperature probe (T5).

The heat exchanger (coil) should be installed below the temperature probe.

Indoor Unit		60	100	160
Volume of tank/L	Recommended	100~250	150~300	200~500
Heat exchange area/m ² (Stainless steel coil)	Minimum	1.4	1.4	1.6
Heat exchange area/m ² (Enamel coil)	Minimum	2.0	2.0	2.5

Room thermostat(field supply)

Room thermostat can be connected to the unit(room thermostat should be kept away from heating source when selecting the installation place).

Solar kit for domestic hot water tank(field supply)

An optional solar kit can be connected to the unit.

Operation range

Operating range of indoor unit		
Outlet water (Heating mode)	+12 ~ +65 C	
Outlet water (Cooling mode)	+5 ~ +25 C	
Domestic hot water	+12 ~ +60 C	
Ambient temperature	+5 ~ +35 C	
Water pressure	0.1~0.3MPa	
Water flow	60	0.40~1.25m ³ /h
	100	0.40~2.10m ³ /h
	160	0.70~3.00m ³ /h

The unit have a freeze prevention function that uses the heat pump or backup heater (Customized model) to keep the water system safe from freezing in all conditions. Since a power failure may happen when the unit is unattended, It's suggested to use anti-freezing flow switch in the water system. (Refer to **8.5 "Water piping"**).

In cooling mode, the water flowing temperature (TW_out) range in different outdoor temperature (T4) is list below:

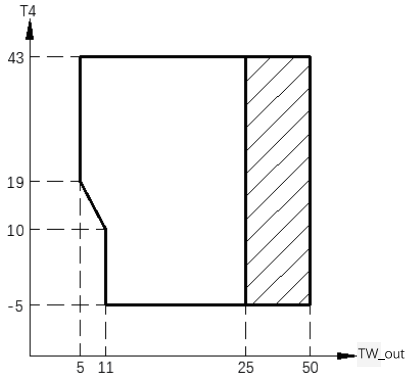

Operation range by heat pump with possible limitation and protection.

In heating mode, the water flowing temperature (TW_out) range in different outdoor temperature (T4) is listed below:

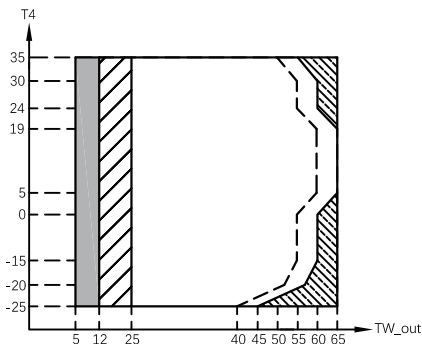

If IBI/AHS setting is valid, only IBI/AHS turns on;
 If IBI/AHS setting is invalid, only heat pump turns on, limitation and protection may occur during heat pump operation.
 Operation range by heat pump with possible limitation and protection.
 Heat pump turns off, only IBI/AHS turns on.
 - - - Maximum inlet water temperature line for heat pump operation.

In DHW mode, the water flowing temperature (TW_out) range in different outdoor temperature (T4) is listed below:

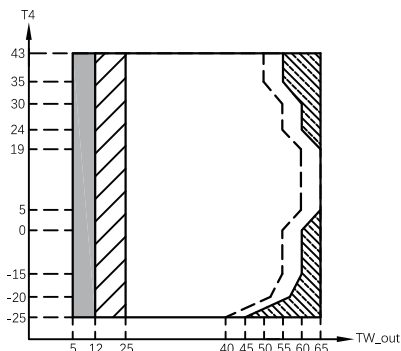

If IBI/AHS setting is valid, only IBI/AHS turns on;
 If IBI/AHS setting is invalid, only heat pump turns on, limitation and protection may occur during heat pump operation.
 Operation range by heat pump with possible limitation and protection.
 Heat pump turns off, only IBI/AHS turns on.
 - - - Maximum inlet water temperature line for heat pump operation.

6 ACCESSORIES

Installation Fittings				
Name	Shape	Quantity		
		60	100	160
Installation and owner's manual (this book)		1	1	1
Operation manual		1	1	1
M16 Copper Nut Tamper Cap		1	1	1
M9 Copper Nut Tamper Cap		0	1	1
M6 Copper Nut Tamper Cap		1	0	0
M8 expansion screws		5	5	5
Thermistor for domestic hot water tank or zone 2 water flow		1	1	1
M16 Copper nut		1	1	1
Y-shape filter		1	1	1
Mounting bracket		1	1	1
Operation manual (Wire controller)		1	1	1

Accessories available from supplier		
Thermistor for balance tank (Tbt1)		1
Extension wire for Tbt1		1
Thermistor for Zone 2 flow temp. (Tw2)		1
Extension wire for Tw2		1
Thermistor for solar temp. (Tsolar)		1
Extension wire for Tsolar		1

Thermistor and extension wire for Tbt1, Tw2, Tsolar can be shared, if these functions are needed at the same time, and 10m in length of the sensor cable please order these thermistors and extension wire additionally.

7 TYPICAL APPLICATIONS

The application examples given below are for illustration only.

7.1 Application 1

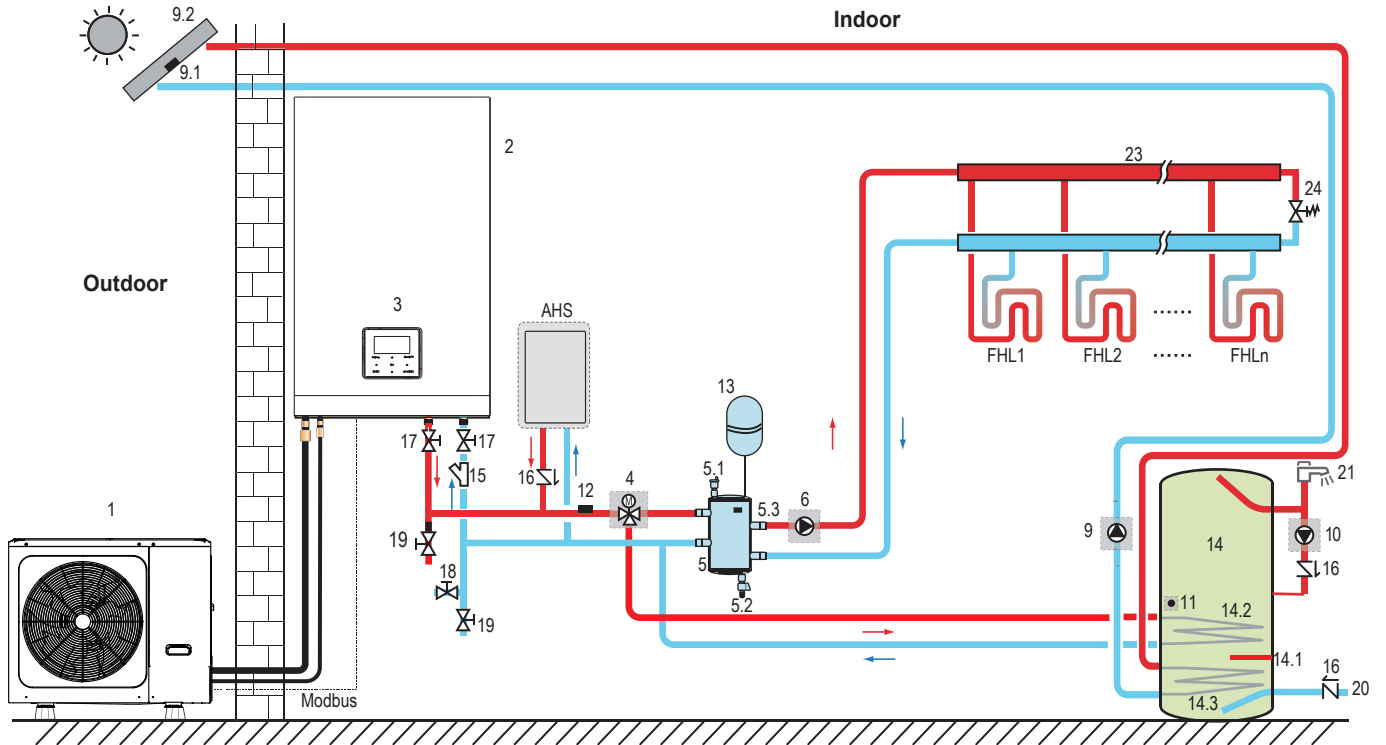

Code	Assembly unit	Code	Assembly unit
1	Outdoor unit	13	Expansion vessel (Field supply)
2	Hydraulic module	14	Domestic hot water tank (Field supply)
3	User interface	14.1	TBH: Domestic hot water tank booster heater (Field supply)
4	SV1:3-way valve (Field supply)	14.2	Coil 1, heat exchanger for heat pump
5	Balance tank (Field supply)	14.3	Coil 2, heat exchanger for Solar energy
5.1	Automatic air purge valve	15	Filter (Accessory)
5.2	Drainage valve	16	Check valve (Field supply)
5.3	Tbt1: Balance tank upper temperature sensor (Optional)	17	Shut-off valve (Field supply)
6	P_o: Zone A circulation pump (Field supply)	18	Filling valve (Field supply)
9	P_s: Solar pump (Field supply)	19	Drainage valve (Field supply)
9.1	Tsolar: Solar temperature sensor (Optional)	20	Tap water inlet pipe (Field supply))
9.2	Solar panel (Field supply)	21	Hot water tap (Field supply)
10	P_d: DWH pipe pump (Field supply)	23	Collector/distributor (Field supply)
11	T5: Domestic water tank temperature sensor (Accessory)	24	Bypass valve (Field supply)
12	T1: Total water flow temperature sensor (Optional)	FHL1...n	Floor heating loop (Field supply)
		AHS	Auxiliary heat source (Field supply)

- **Space heating**

The ON/OFF signal and operation mode and temperature setting are set on the user interface. P_o(6) keeps running as long as the unit is ON for space heating, SV1(4) keeps OFF.

- **Domestic water heating**

The ON/OFF signal and target tank water temperature (T5S) are set on the user interface. P_o(6) stops running as long as the unit is ON for domestic water heating, SV1(4) keeps ON.

- **AHS (auxiliary heat source) control**

The AHS function is set on the indoor unit (See 9.1 "DIP switch settings overview")

1) When the AHS is set to be valid only for heating mode, AHS can be turned on in the following ways:

- a. Turn on the AHS via BACKHEATER function on the user interface;
- b. AHS will be turned on automatically if initial water temperature is too low or target water temperature is too high at low ambient temperature.

P_o(6) keeps running as long as the AHS is ON, SV1(4) keeps OFF.

2) When the AHS is set to be valid for heating mode and DHW mode. In heating mode, AHS control is same as part 1); In DHW mode, AHS will be turned on automatically when the initial domestic water temperature T5 is too low or the target domestic water temperature is too high at low ambient temperature. P_o(6) stops running, SV1(4) keeps ON.

3) When the AHS is set to be valid, M1M2 can be set to be valid on the user interface. In heating mode, AHS will be turned on if M1M2 dry contact closes. This function is invalid in DHW mode.

- **TBH (tank booster heater) control**

The TBH function is set on the user interface. (See 9.1 "DIP switch settings overview")

1) When the TBH is set to be valid, TBH can be turned on via TANK HEATER function on the user interface; In DHW mode, TBH will be turned on automatically when the initial domestic water temperature T5 is too low or the target domestic water temperature is too high at low ambient temperature.

2) When the TBH is set to be valid, M1M2 can be set to be valid on the user interface. TBH will be turned on if M1M2 dry contact closes.

- **Solar energy control**

Hydraulic module recognizes solar energy signal by judging Tsolar or receiving SL1SL2 signal from user interface. The recognition method can be set via SOLAR INPUT on the user interface. Please refer to 8.8.6/1 "For solar energy input signal" for wiring.(see 9.5.15 "INPUT DEFINE")

1) When Tsolar is set to be valid, Solar energy turns ON when Tsolar is high enough, P_s(9) starts running; Solar energy turns OFF when Tsolar is low, P_s(9) stops running.

2) When SL1SL2 control is set to be valid, Solar energy turns ON after receiving Solar kit signal from user interface, P_s(9) starts running; Without solar kit signal. Solar energy turns OFF, P_s(9) stops running.

 **CAUTION**

The highest outlet water temperature may reach 70°C, please beware of burns.

 **NOTE**

Make sure to fit the (SV1) 3-way valve correctly. For more details, please refer to 8.8.6 "Connection for other components. At extremely low ambient temperature, the domestic hot water is exclusively heated by TBH, which assures that heat pump can be used for space heating with full capacity.

Details on domestic hot water tank configuration for low outdoor temperatures (T4DHWMIN) can be found in 9.5.1 "DHW MODE SETTING".

7.2 Application 2

ROOM THERMOSTAT Control for Space heating or cooling need to be set on the user interface. It can be set in three ways: MODE SET/ONE ZONE/DOUBLE ZONE. The indoor unit can be connected to a high voltage room thermostat and a low voltage room thermostat. A thermostat transfer board can also be connected. Another six thermostats can be connected to the thermostat transfer board. Please refer to 8.8.6/6) "For room thermostat" for wiring. (see 9.5.6 "ROOM THERMOSTAT")

7.2.1 One zone control

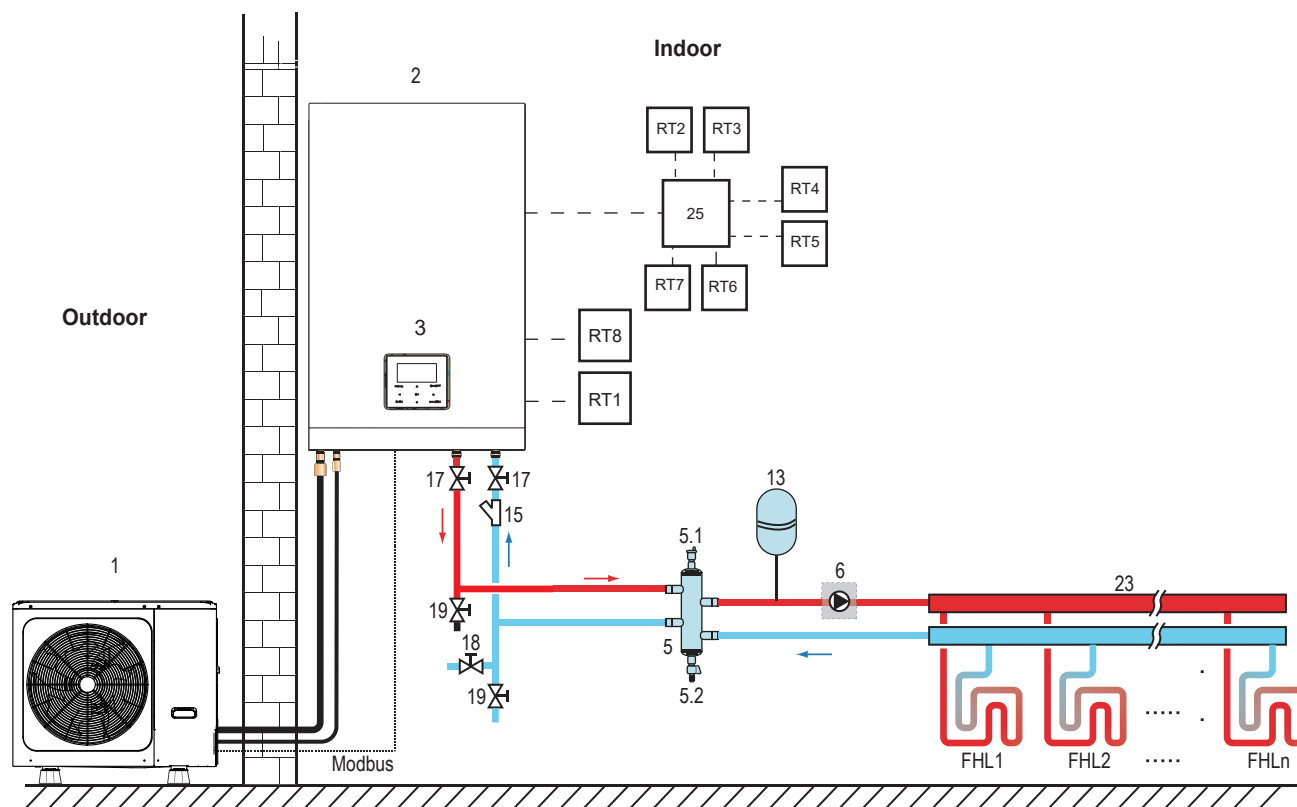

Code	Assembly unit	Code	Assembly unit
1	Outdoor unit	17	Shut-off valve (Field supply)
2	Indoor unit	18	Filling valve (Field supply)
3	User interface	19	Drainage valve (Field supply)
5	Balance tank (Field supply)	23	Collector/distributor (Field supply)
5.1	Automatic air purge valve	25	Thermostat transfer board (Optional)
5.2	Drainage valve	RT 1...7	Low voltage room thermostat (Field supply)
6	P _o : Outside circulation pump (Field supply)	RT8	High voltage room thermostat (Field supply)
13	Expansion vessel (Field supply)	FHL 1...n	Floor heating loop (Field supply)
15	Filter (Accessory)		

- **Space heating**

One zone control: the unit ON/OFF is controlled by the room thermostat, cooling or heating mode and outlet water temperature are set on the user interface. System is ON when any "HL" of all the thermostats closes. When all "HL" open, system turns OFF.

- **The circulation pumps operation**

When the system is ON, which means any "HL" of all the thermostats closes, P_o(6) starts running; When the system is OFF, which means all "HL" close, P_o(6) stops running.

7.2.2 Mode set control

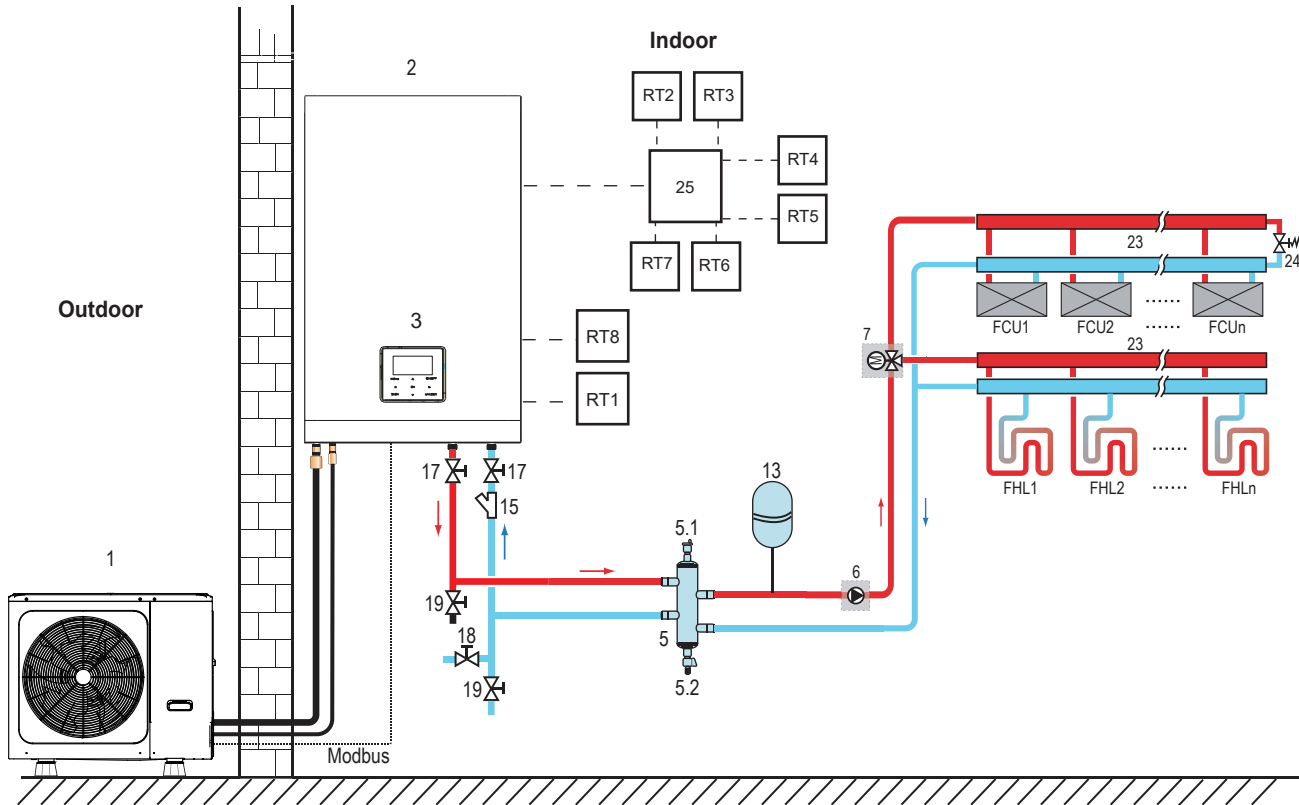

Code	Assembly unit	Code	Assembly unit
1	Outdoor unit	17	Shut-off valve (Field supply)
2	Indoor unit	18	Filling valve (Field supply)
3	User interface	19	Drainage valve (Field supply)
5	Balance tank (Field supply)	23	Collector/distributor (Field supply)
5.1	Automatic air purge valve	24	Bypass valve (Field supply)
5.2	Drainage valve	25	Thermostat transfer board (Optional)
6	P_o: Outside circulation pump (Field supply)	RT 1...7	Low voltage room thermostat (Field supply)
7	SV2: 3-way valve (Field supply)	RT8	High voltage room thermostat (Field supply)
13	Expansion vessel (Field supply)	FHL 1...n	Floor heating loop (Field supply)
15	Filter (Accessory)	FCU 1...n	Fan coil unit (Field supply)

• Space heating

Cooling or heating mode is set via the room thermostat, water temperature is set on the user interface.

- 1) When any "CL" of all the thermostats close, system will be set at cooling mode.
- 2) When any "HL" of all the thermostats close and all "CL" open, system will be set at heating mode.

• The circulation pumps operation

- 1) When the system is in cooling mode, which means any "CL" of all the thermostats closes, SV2(7) keeps OFF, P_o(6) starts running;
- 2) When the system is in heating mode, which means one or more "HL" close and all "CL" open, SV2(7) keeps ON, P_o(6) starts running.

7.2.3 Double zone control

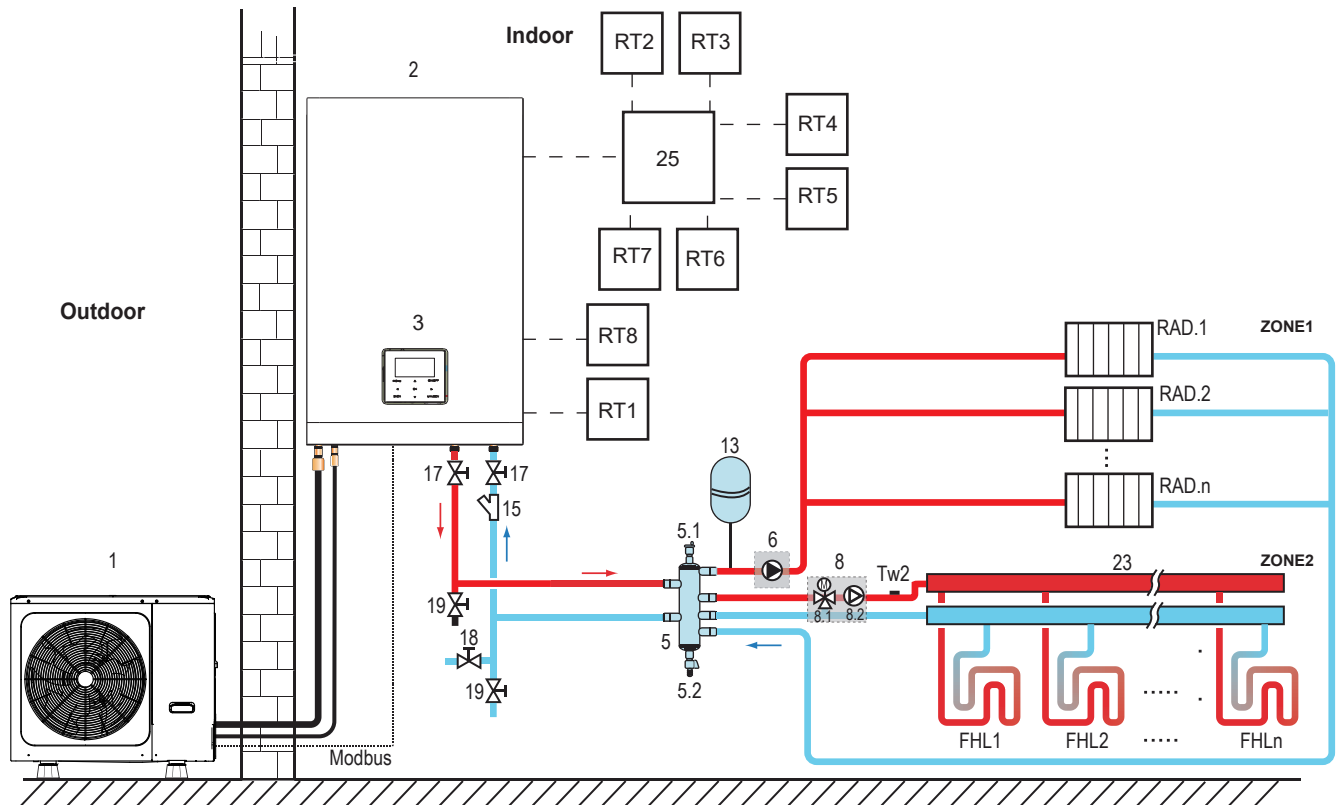

Code	Assembly unit	Code	Assembly unit
1	Outdoor unit	15	Filter (Accessory)
2	Indoor unit	17	Shut-off valve (Field supply)
3	User interface	18	Filling valve (Field supply)
5	Balance tank (Field supply)	19	Drainage valve (Field supply)
5.1	Automatic air purge valve	23	Collector/distributor (Field supply)
5.2	Drainage valve	25	Thermostat transfer board (Optional)
6	P_o: zone 1 circulation pump (Field supply)	RT 1...7	Low voltage room thermostat (Field supply)
8	Mixing station (Field supply)	RT8	High voltage room thermostat (Field supply)
8.1	SV3: Mixing valve (Field supply)	Tw2	Zone 2 water flow temperature sensor (Optional)
8.2	P_c: zone 2 circulation pump	FHL 1...n	Floor heating loop (Field supply)
13	Expansion vessel (Field supply)	RAD. 1...n	Radiator (Field supply)

• Space heating

Zone1 can operate in cooling mode or heating mode, while zone2 can only operate in heating mode; While installation, for all thermostats in zone1, only "H、 L" terminals need to be connected. For all thermostats in zone2, only "C、 L" terminals need to be connected.

1) The ON/OFF of zone1 is controlled by the room thermostats in zone1. When any "HL" of all thermostats in zone1 closes, zone1 turns ON. When all "HL" turn OFF, zone1 turns OFF; Target temperature and operation mode are set on the user interface;

2) In heating mode, the ON/OFF of zone2 is controlled by the room thermostats in zone2. When any "CL" of all thermostats in zone2 closes, zone2 turns ON. When all "CL" open, zone2 turns OFF. Target temperature is set on the user interface; Zone 2 can only operate in heating mode. When cooling mode is set on the user interface, zone2 keeps in OFF status.

• The circulation pump operation

When zone 1 is ON, P_o(6) starts running; When zone 1 is OFF, P_o(6) stops running;

When zone 2 is ON, SV3(8.1) is ON, P_c(8.2) starts running; When zone 2 is OFF, SV3(8.1) is OFF, P_c(8.2) stops running .

The floor heating loops require a lower water temperature in heating mode compared to radiators or fan coil units. To achieve these two set points, a mixing station is used to adapt the water temperature according to requirements of the floor heating loops. The radiators are directly connected to the unit water circuit and the floor heating loops are after the mixing station. The mixing station is controlled by the unit.

 **CAUTION**

- 1) Make sure to connect the SV2/SV3 terminals in the wired controller correctly, please refer to 8.8.6/2)
- 2) Thermostat wires to the correct terminals and to configure the ROOM THERMOSTAT in the wired controller correctly. Wiring of the room thermostat should follow method A/B/C as described in 8.8.6 "Connection for other components / 6) For room thermostat".

 **NOTE**

- 1) Zone 2 can only operate in heating mode. When cooling mode is set on user interface and zone 1 is OFF, "CL" in zone 2 closes, system still keeps "OFF". While installation, the wiring of thermostats for zone 1 and zone 2 must be correct.
- 2) Drainage valve(9) must be installed at the lowest position of the piping system.

The Balance tank volume requirement:

NO.	Indoor unit model	Balance tank (L)
1	60	≥25
2	100	≥25
3	160	≥40

8 OVERVIEW OF THE UNIT

8.1 Disassembling the unit

The indoor unit cover can be removed by removing the 2 screws and unhitching the cover.

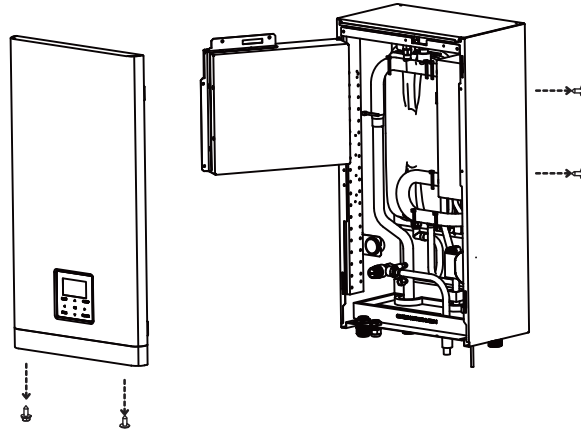

⚠ CAUTION

Make sure to fix the cover with the screws and nylon washers when installing the cover (screws are delivered as accessory) .Parts inside the unit can be hot.

- To gain access to the control box components – e.g. to connect the field wiring – the control box service panel can be removed. Thereo, loosen the front screws and unhitch the control box service panel.

⚠ CAUTION

Switch off all power supply – i.e. outdoor unit power supply ,indoor unit power supply, electric heater and additional heater power supply before removing the control box service panel.

8.2 Main components

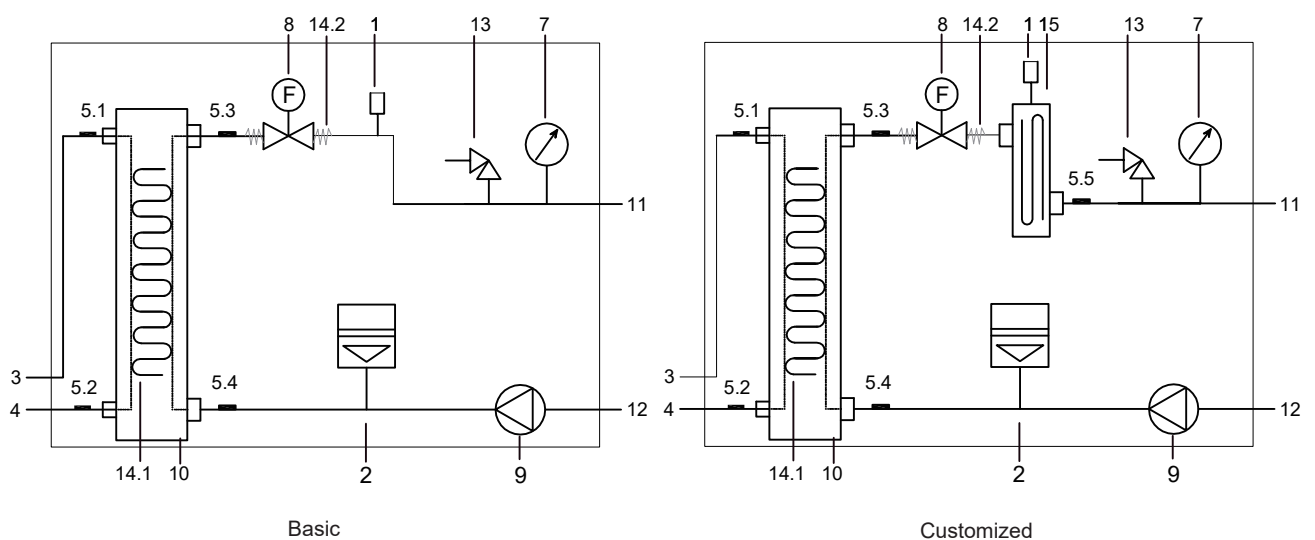

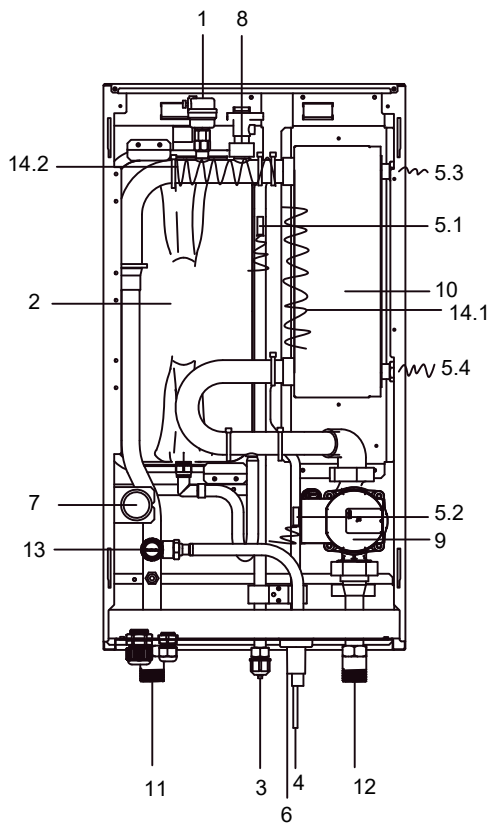

Basic

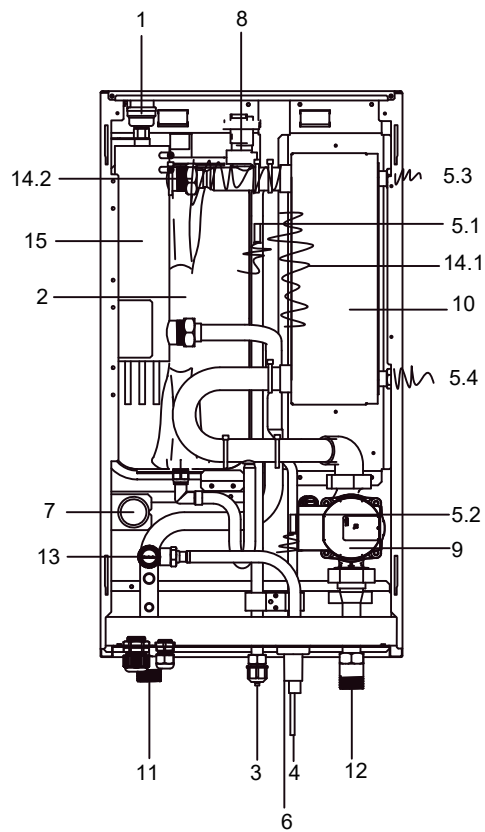

Customized

Code	Assembly unit	Explanation
1	Automatic air purge valve	Remaining air in the water circuit will be automatically removed via the automatic air purge valve.
2	Expansion vessel (8 L)	/
3	Refrigerant gas pipe	/
4	Refrigerant liquid pipe	/
5	Temperature sensors	Four temperature sensors determine the water and refrigerant temperature at various points. 5.1-T2B; 5.2-T2; 5.3-Tw_out; 5.4-Tw_in; 5.5-T1
6	Drainage port	/
7	Manometer	The manometer allows readout of the water pressure in the water circuit.
8	Flow switch	If water flow is below 0.6 m ³ /h, the flow switch open, then when the water flow reach 0.66 m ³ /h,the flow switch close.
9	Pump_i	The pump circulates the water in the water circuit.
10	Plate heat exchanger	Heat exchanging between water and refrigerant.
11	Water outlet pipe	/
12	Water inlet pipe	/
13	Pressure relief valve	The pressure relief valve prevents excessive water pressure in the water circuit by opening at 43.5psi(g)/0.3MPa(g) and discharging some water.
14	Electrical heating belt(14.1-14.2)	They are for preventing frozen.(14.2 is optional)
15	Internal backup heater	The backup heater consists of an electrical heating element that will provide additional heating capacity to the water circuit if the heating capacity of the unit is insufficient due to low outdoor temperatures, it also protects the external water piping from freezing during cold periods.

8.3 Electronic control box

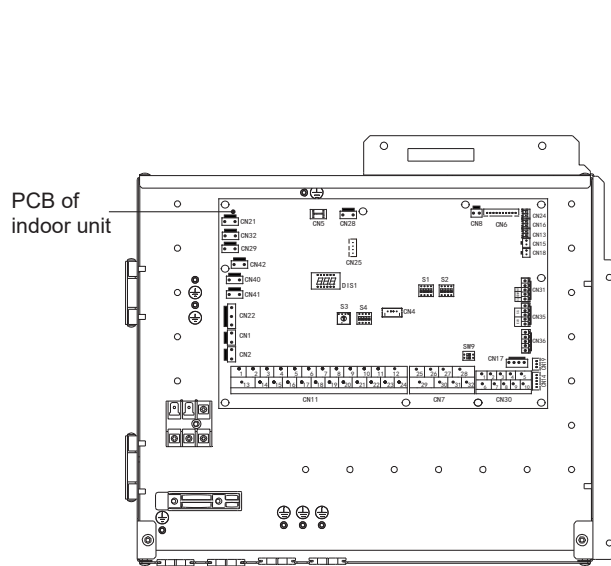

Basic

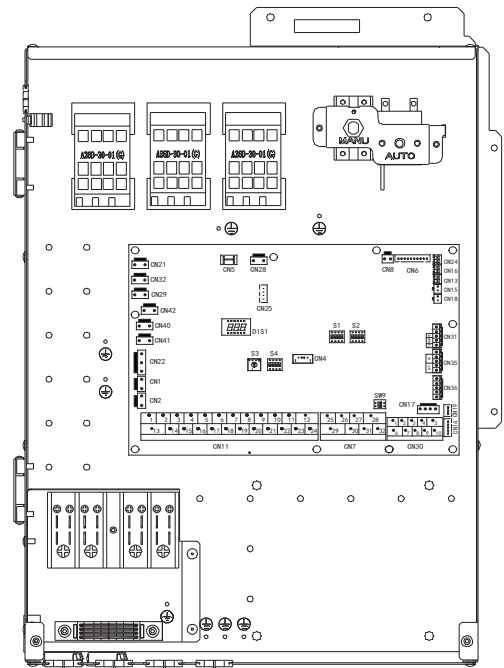

Customized

NOTE

The picture is only for reference, please refer to the actual product.

8.3.1 Main control board of indoor unit

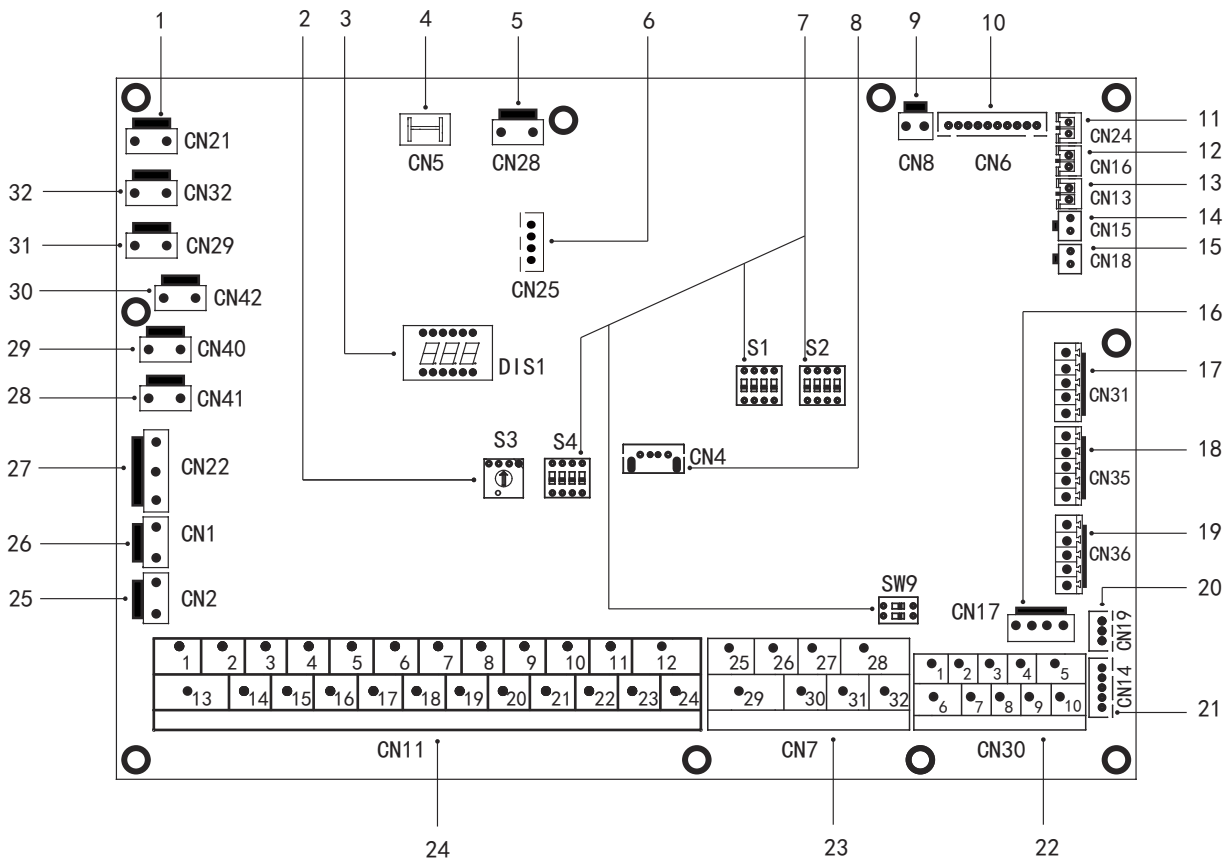

Order	Port	Code	Assembly unit	Order	Port	Code	Assembly unit
1	CN21	POWER	Port for power supply	19	CN36	M1 M2 T1 T2	Port for remote switch Port for thermostat transfer board
2	S3	/	Rotary dip switch	20	CN19	P Q	Communicate port between indoor unit and outdoor unit
3	DIS1	/	Digital display	21	CN14	A B X Y E	Port for communication with the wired controller
4	CN5	GND	Port for ground			1 2 3 4 5	Port for communication with the wired controller
5	CN28	PUMP	Port for variable speed pump power input	22	CN30	6 7	Communicate port between indoor unit and outdoor unit
6	CN25	DEBUG	Port for IC programming			9 10	Port for Internal machine Parallel
7	S1,S2,S4,SW9	/	Dip switch			26 30/31 32	Compressor run/Defrost run
8	CN4	USB	Port for USB programming	23	CN7	25 29	Port for antifreeze E-heating tape(external)
9	CN8	FS	Port for flow switch			27 28	Port for additional heat source
10	CN6	T2	Port for temperature sensor of refrigerant liquid side temperature of indoor unit (heating mode)			1 2	Input port for solar energy
		T2B	Port for temperature sensor of refrigerant gas side temperature of indoor unit (cooling mode)			3 4 15	Port for room thermostat
		TW_in	Port for temperature sensor of inlet water temperature of plate heat exchanger			5 6 16	Port for SV1(3-way valve)
		TW_out	Port for temperature sensor of outlet water temperature of plate heat exchanger			7 8 17	Port for SV2(3-way valve)
		T1	Port for temperature sensor of final outlet water temperature of indoor unit	24	CN11	9 21	Port for zone 2 pump
11	CN24	Tbt1	Port for upper temp. sensor of balance tank			10 22	Port for outside circulation pump
12	CN16	Tbt2	Port for lower temp. sensor of balance tank			11 23	Port for solar energy pump
13	CN13	T5	Port for domestic hot water tank temp. sensor			12 24	Port for DHW pipe pump
14	CN15	Tw2	Port for zone 2 temp.sensor of outlet water			13 16	Control port for tank booster heater
15	CN18	Tsolar	Port for solar panel temp. sensor	25	CN2	TBH_FB	Feedback port for external temperature switch(shorted in default)
16	CN17	PUMP_BP	Port for variable speed pump communication	26	CN1	IBH1/2_FB	Feedback port for temperature switch (shorted in default)
17	CN31	HT	Control port for room thermostat (heating mode)			IBH1	Control port for internal backup heater 1
		COM	Power port for room thermostat	27	CN22	IBH2	Reserved
		CL	Control port for room thermostat (cooling mode)			TBH	Control port for tank booster heater
18	CN35	SG	Port for smart grid (grid signal)	28	CN41	HEAT8	Port for anti-freeze electric heating tape(internal)
		EVU	Port for smart grid (photovoltaic signal)	29	CN40	HEAT7	Port for anti-freeze electric heating tape(internal)
				30	CN42	HEAT6	Port for anti-freeze electric heating tape(internal)
				31	CN29	HEAT5	Port for anti-freeze electric heating tape(internal)
				32	CN32	IBH0	Port for backup heater

8.4 Refrigerant pipework

For all guidelines, instructions and specifications regarding refrigerant pipework between the indoor unit and outdoor unit, please refer to "Installation and owner's manual (M-thermal split outdoor unit)".

⚠ CAUTION

When connecting the refrigerant pipes, always use two wrenches/spanners for tightening or loosening nuts! Failure to do so can result in damaged piping connections and leaks.

💡 NOTE

- The appliance contains fluorinated greenhouse gases. Chemical name of the gas: R32
- Fluorinated greenhouse gases are contained in hermetically sealed equipment.
- An electrical switchgear has a tested leakage rate of less than 0.1 % per year as set out in the technical specification of the manufacturer.

8.5 Water piping

All piping lengths and distances have been taken into consideration. Refer to Table. 3-1.

💡 NOTE

If no glycol is in the system, in case of a power supply failure or pump operating failure, drain all the water system if the water temperature is below 0°C in the cold winter (as suggested in the figure below).

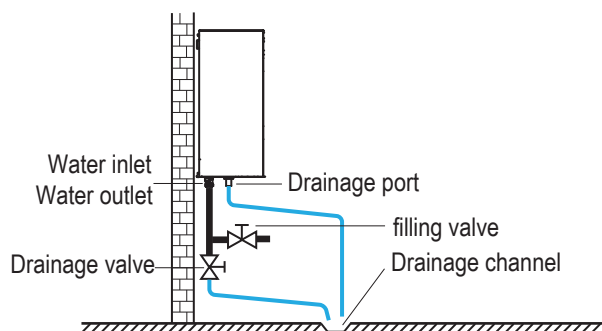

When water is at standstill inside the system, freezing is very likely to happen and damage the system in the process.

8.5.1 Check the water circuit

The unit is equipped with a water inlet and water outlet for connection to a water circuit. This circuit must be provided by a licensed technician and must comply with local laws and regulations.

The unit is only to be used in a closed water system. Application in an open water circuit can lead to excessive corrosion of the water piping.

Example:

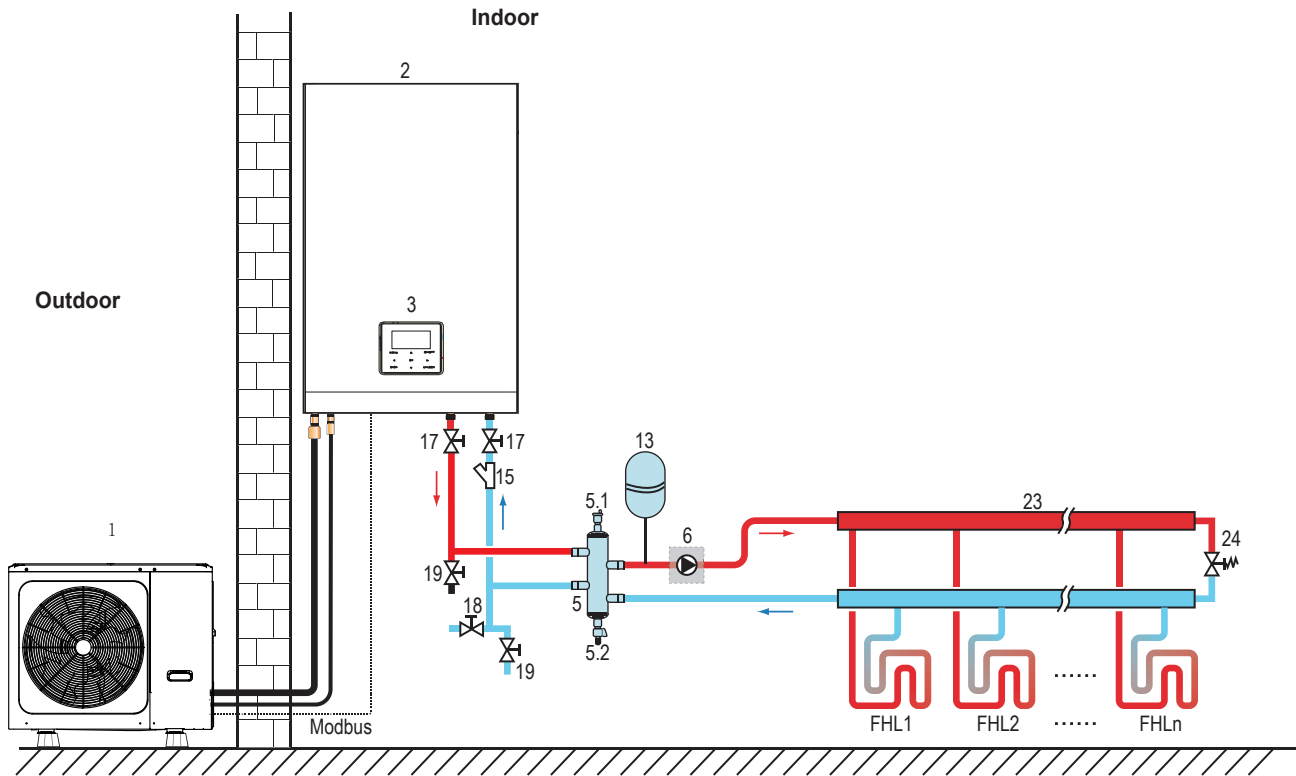

Code	Assembly unit	Code	Assembly unit
1	Outdoor unit	15	Filter (accessory)
2	Indoor unit	17	Shut-off valve (field supply)
3	User interface (accessory)	18	Filling valve (field supply)
5	Balance tank (field supply)	19	Drainage valve (field supply)
5.1	Automatic air purge valve	23	Collector/distributor (field supply)
5.2	Drainage valve	24	Bypass valve (field supply)
6	P_o: Outside circulation pump (field supply)	FHL 1...n	Floor heating loop (field supply)
13	Expansion vessel (field supply)		

Before continuing installation of the unit, check the following:

- The maximum water pressure ≤ 3 bar.
- The maximum water temperature $\leq 70^{\circ}\text{C}$ according to safety device setting.
- Always use materials that are compatible with the water used in the system and with the materials used in the unit.
- Ensure that components installed in the field piping can withstand the water pressure and temperature.
- Drain taps must be provided at all low points of the system to permit complete drainage of the circuit during maintenance.
- Air vents must be provided at all high points of the system. The vents should be located at points that are easily accessible for service. An automatic air purge is provided inside the unit. Check that this air purge valve is not tightened so that automatic release of air in the water circuit is possible.

8.5.2 Water volume and sizing expansion vessels

The units are equipped with an expansion vessel of 8L that has a default pre-pressure of 1.5 bar. To assure proper operation of the unit, the pre-pressure of the expansion vessel might need to be adjusted.

1) Check that the total water volume in the installation, excluding the internal water volume of the unit, is at least 40L. See **13 "Technical specifications"** to find the total internal water volume of the unit.

NOTE

- In most applications this minimum water volume will be satisfactory.
- In critical processes or in rooms with a high heat load though, extra water might be required.
- When circulation in each space heating loop is controlled by remotely controlled valves, it is important that this minimum water volume is kept even if all the valves are closed.

2) Expansion vessel volume must fit the total water system volume.

3) To size the expansion for the heating and cooling circuit.

The expansion vessel volume can follow the figure below:

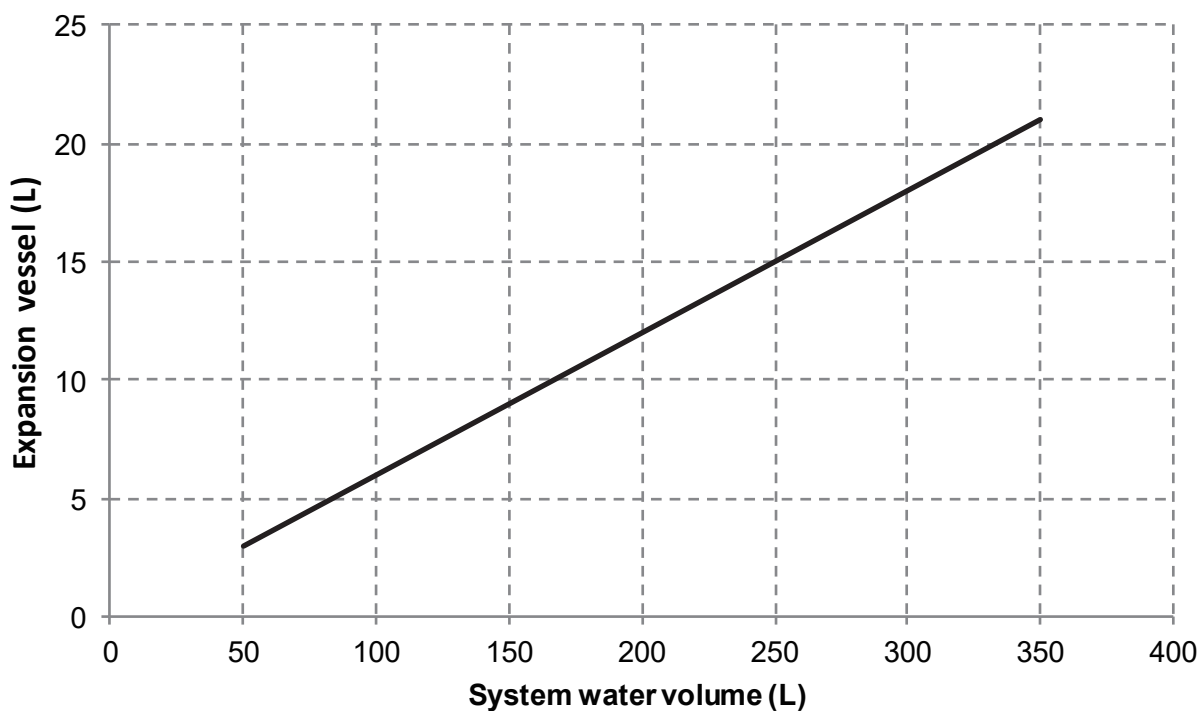

8.5.3 Water circuit connection

Water connections must be made correctly in accordance with labels on the indoor unit, with respect to the water inlet and water outlet.

CAUTION

Be careful not to deform the unit's piping by using excessive force when connecting the piping. Deforming the piping can cause the unit to malfunction.

If air, moisture or dust gets in the water circuit, problems may occur. Therefore, always take into account the following when connecting the water circuit:

- Use clean pipes only.
- Hold the pipe end downwards when removing burrs.
- Cover the pipe end when inserting it through a wall to prevent dust and dirt entering.
- Use a good thread sealant for sealing the connections. The sealing must be able to withstand the pressures and temperatures of the system.
- When using non-copper metallic piping, be sure to insulate two kind of materials from each other to prevent galvanic corrosion.
- As copper is a soft material, use appropriate tools for connecting the water circuit. Inappropriate tools will cause damage to the pipes.

NOTE

The unit is only to be used in a closed water system. Application in an open water circuit can lead to excessive corrosion of the water piping:

- Never use Zn-coated parts in the water circuit. Excessive corrosion of these parts may occur as copper piping is used in the unit's internal water circuit.
- When using a 3-way valve in the water circuit. Preferably choose a ball type 3-way valve to guarantee full separation between the domestic hot water and floor heating water circuit.
- When using a 3-way valve or a 2-way valve in the water circuit. The recommended maximum changeover time of the valve should be less than 60 seconds.

8.5.4 Water circuit anti-freeze protection

All internal hydronic parts are insulated to reduce heat loss. Insulation must also be added to the field piping.

The software contains special functions using the heat pump and backup heater (if it is available) to protect the entire system against freezing. When the temperature of the water flow in the system drops to a certain value, the unit will heat the water, either using the heat pump, the electric heating tap, or the backup heater. The freeze protection function will turn off only when the temperature increases to a certain value.

In event of a power failure, the above features would not protect the unit from freezing.

CAUTION

When the unit is not running for a long time, make sure the unit is powered on all the time, if you want to cut off the power, the water in the system pipe needs to be drained clean, avoid the pump and pipeline system be damaged by freezing. Also the power of the unit needs to be cut off after water in the system is drained clean.

Water may enter into the flow switch and cannot be drained out and may freeze when the temperature is low enough. The flow switch should be removed and dried, then can be reinstalled in the unit.

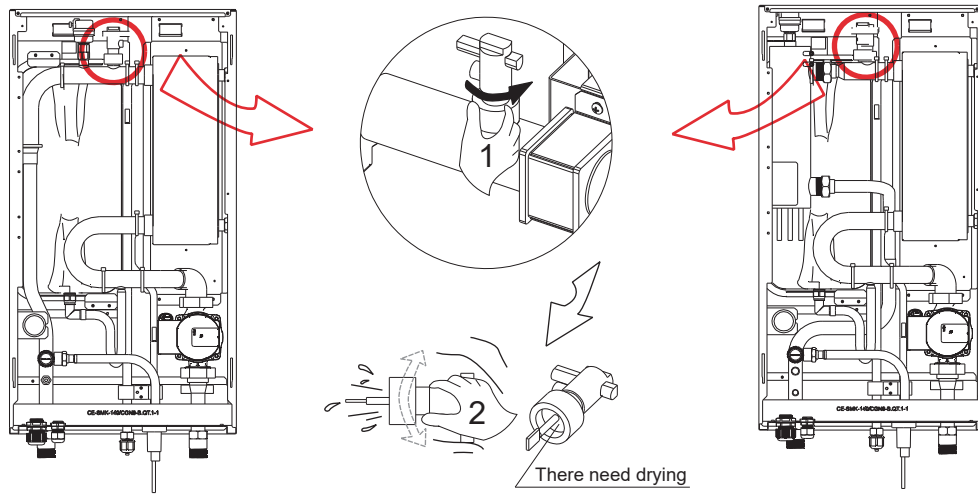

NOTE

1. Counterclockwise rotation, remove the flow switch.
2. Drying the flow switch completely.

8.6 Filling water

- Connect the water supply to the filling valves and open the valve.
- Make sure all the automatic air purge valves are open (at least 2 turns).
- Filling with water until the manometer indicates a pressure of approximately 2.0 bar. Remove air in the circuit as much as possible using the automatic air purge valves.

Do not fasten the black plastic cover on the automatic bleed valve at the top side of the unit when the system is running. Open the automatic bleed valve, turn counterclockwise at least 2 full turns to release air from the system.

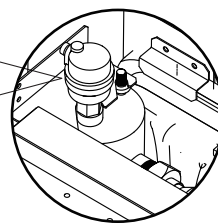

NOTE

During filling, it might not be possible to remove all air in the system. Remaining air will be removed through the automatic bleed valve during the first operating hours of the system. Topping up the water afterwards might be required.

- The water pressure indicated on the manometer will vary depending on the water temperature (higher pressure at higher water temperature). However, at all times water pressure should remain above 0.3 bar to avoid air entering the circuit.
- The unit might drain-off too much water through the pressure relief valve.
- Water quality should be complied with EN 98/83 EC Directives.
- Detailed water quality condition can be found in EN 98/83 EC Directives.

8.7 Water piping insulation

The complete water circuit including all piping, water piping must be insulated to prevent condensation during cooling operation and reduction of the heating and cooling capacity as well as prevention of freezing of the outside water piping during winter. The insulation material should at least of B1 fire resistance rating and complies with all applicable legislation. The thickness of the sealing materials must be at least 13 mm with thermal conductivity 0.039 W/mK in order to prevent freezing on the outside water piping.

If the outdoor ambient temperature is higher than 30°C and the humidity is higher than RH 80%, then the thickness of the sealing materials should be at least 20 mm in order to avoid condensation on the surface of the seal.

8.8 Field wiring

WARNING

A main switch or other means of disconnection, having a contact separation in all poles, must be incorporated in the fixed wiring in accordance with relevant local laws and regulations. Switch off the power supply before making any connections. Use only copper wires. Never squeeze bundled cables and make sure they do not come in contact with the piping and sharp edges. Make sure no external pressure is applied to the terminal connections. All field wiring and components must be installed by a licensed electrician and must comply with relevant local laws and regulations.

The field wiring must be carried out in accordance with the wiring diagram supplied with the unit and the instructions given below.

Be sure to use a dedicated power supply. Never use a power supply shared by another appliance.

Be sure to establish a ground. Do not ground the unit to a utility pipe, surge protector, or telephone ground. Incomplete grounding may cause electrical shock.

Be sure to install a ground fault circuit interrupter (30 mA). Failure to do so may cause electrical shock.

Be sure to install the required fuses or circuit breakers.

8.8.1 Precautions on electrical wiring work

- Fix cables so that cables do not make contact with the pipes (especially on the high pressure side).
- Secure the electrical wiring with cable ties as shown in figure so that it does not come in contact with the piping, particularly on the high-pressure side.
- Make sure no external pressure is applied to the terminal connectors.
- When installing the ground fault circuit interrupter make sure that it is compatible with the inverter (resistant to high frequency electrical noise) to avoid unnecessary opening of the ground fault circuit interrupter.

NOTE

The ground fault circuit interrupter must be a high-speed type breaker of 30 mA (<0.1 s).

- This unit is equipped with an inverter. Installing a phase advancing capacitor not only will reduce the power factor improvement effect, but also may cause abnormal heating of the capacitor due to high-frequency waves. Never install a phase advancing capacitor as it could lead to an accident.

8.8.2 Wiring overview

The illustration below gives an overview of the required field wiring between several parts of the installation. Refer also to "7 Typical application".

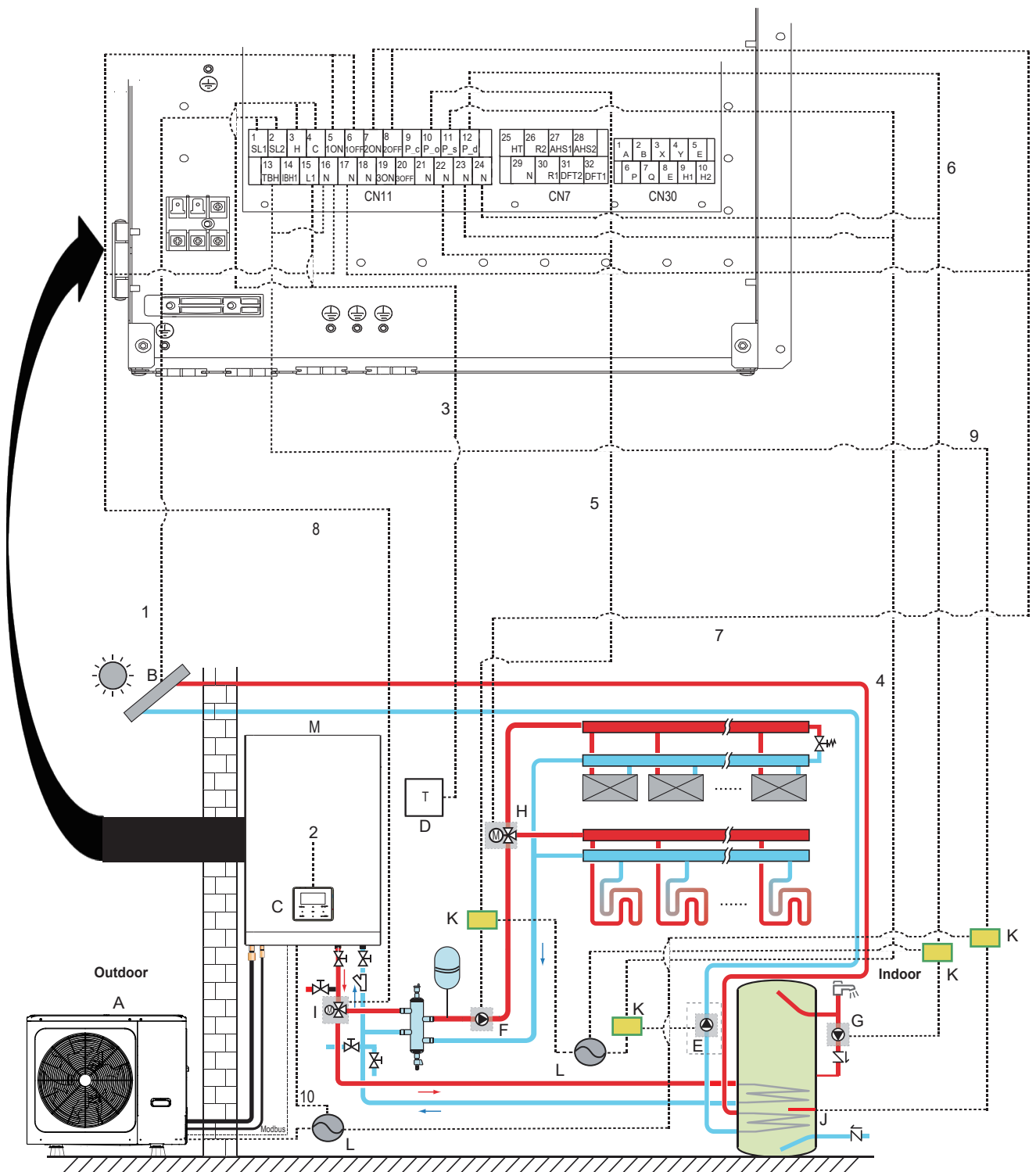

Code	Assembly unit	Code	Assembly unit
A	Outdoor unit	H	SV2: 3-way valve (field supply)
B	Solar energy kit (field supply)	I	SV1: 3-way valve for domestic hot water tank (field supply)
C	User interface	J	Booster heater
D	High voltage room thermostat (field supply)	K	Contactora
E	P_s: Solar pump (field supply)	L	Power supply
F	P_o: Outside circulation pump (field supply)	M	Indoor unit
G	P_d: DHW pump (field supply)		

Item	Description	AC/DC	Required number of conductors	Maximum running current	
1	Solar energy kit signal cable	AC	2	200mA	
2	User interface cable	AC	5	200mA	
3	Room thermostat cable	AC	2	200mA(a)	
4	Solar pump control cable	AC	2	200mA(a)	
5	Outside circulation pump control cable	AC	2	200mA(a)	
6	DHW pump control cable	AC	2	200mA(a)	
7	SV2: 3-way valve control cable	AC	3	200mA(a)	
8	SV1: 3-way valve control cable	AC	3	200mA(a)	
9	Booster heater control cable	AC	2	200mA(a)	
10	Power supply cable for indoor unit	AC	2+GND	60	0.4A
				100	0.4A
				160	0.4A
			4+GND	60 (3kW heater)	13.5A
				100(3kW heater)	13.5A
				160(3kW heater)	13.5A
4+GND	60 (9kW heater)	13.3A			
	100(9kW heater)	13.3A			
	160(9kW heater)	13.3A			

(a) Minimum cable section AWG18 (0.75 mm²).

(b) The thermistor cable are delivered with the unit: if the current of the load is large, an AC contactor is needed.

NOTE

Please use H07RN-F for the power wire, all the cables are connect to high voltage except for thermistor cable and cable for user interface.

- Equipment must be grounded.
- All high-voltage external load, if it is metal or a grounded port, must be grounded.
- All external load current is needed less than 0.2A, if the single load current is greater than 0.2A, the load must be controlled through AC contactor.
- "AHS1" "AHS2", "A1" "A2", "R1" "R2" and "DFT1" "DFT2" wiring terminal ports provide only the switch signal. Please refer to image of 8.8.6 to get the ports position in the unit.
- Plate heat exchanger E-Heating tape and Flow switch E-Heating tape share a control port.

Field wiring guidelines

- Most field wiring on the unit is to be made on the terminal block inside the switch box. To gain access to the terminal block, remove the switch box service panel.

WARNING

Switch off all power including the unit power supply and backup heater and domestic hot water tank power supply (if applicable) before removing the switch box service panel.

- Fix all cables using cable ties.
- A dedicated power circuit is required for the backup heater.
- Installations equipped with a domestic hot water tank (field supply) require a dedicated power circuit for the booster heater. Please refer to the domestic hot water tank Installation & Owner's Manual.
- Lay out the electrical wiring so that the front cover does not rise up when doing wiring work and attach the front cover securely.
- Follow the electric wiring diagram for electrical wiring works (the electric wiring diagrams are located on the rear side of door 2).
- Install the wires and fix the cover firmly so that the cover may be fit in properly.

8.8.3 Precautions on wiring of power supply

- Use a round crimp-style terminal for connection to the power supply terminal board. In case it cannot be used due to unavoidable reasons, be sure to observe the following instructions.
 - Do not connect different gauge wires to the same power supply terminal. (Loose connections may cause overheating.)
 - When connecting wires of the same gauge, connect them according to the figure below.

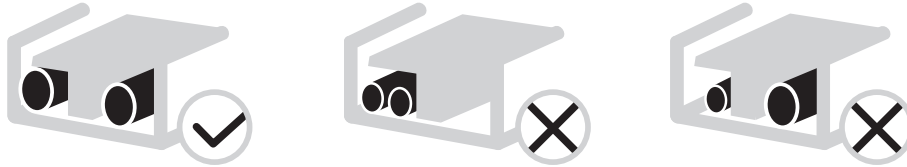

- Use the correct screwdriver to tighten the terminal screws. Small screwdrivers can damage the screw head and prevent appropriate tightening.
- Over-tightening the terminal screws can damage the screws.
- Attach a ground fault circuit interrupter and fuse to the power supply line.
- In wiring, make certain that prescribed wires are used, carry out complete connections, and fix the wires so that outside force cannot affect the terminals.

8.8.4 Safety device requirements

1. Select the wire diameters(minimum value) individually for each unit based on the table below.
2. Select circuit breaker that having a contact separation in all poles not less than 3 mm providing full disconnection, where MFA is used to select the current circuit breakers and residual current operation breakers:

System	Power Current						IWPM	
	Hz	Voltage (V)	Min. (V)	Max. (V)	MCA (A)	MFA (A)	kW	FLA (A)
60	50	220-240/1N	198	264	1.20	/	0.087	0.66
100	50	220-240/1N	198	264	1.20	/	0.087	0.66
160	50	220-240/1N	198	264	1.20	/	0.087	0.66
60(3kW heater)	50	220-240/1N	198	264	14.30	/	0.087	0.66
100(3kW heater)	50	220-240/1N	198	264	14.30	/	0.087	0.66
160(3kW heater)	50	220-240/1N	198	264	14.30	/	0.087	0.66
60(9kW heater)	50	380-415/3N	342	456	14.00	/	0.087	0.66
100(9kW heater)	50	380-415/3N	342	456	14.00	/	0.087	0.66
160(9kW heater)	50	380-415/3N	342	456	14.00	/	0.087	0.66

NOTE

MCA : Max. Circuit Amps. (A)
MFA : Max. Fuse Amps. (A)
IWPM : Indoor Water Pump Motor
FLA : Full Load Amps. (A)

8.8.5 Specifications of standard wiring components

Equipment main Power Supply Wiring

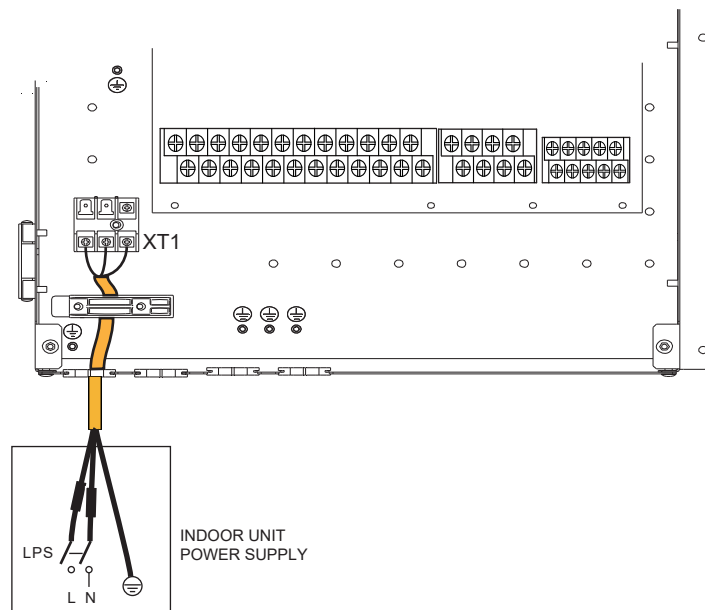

- Stated values are maximum values (see electrical data for exact values).

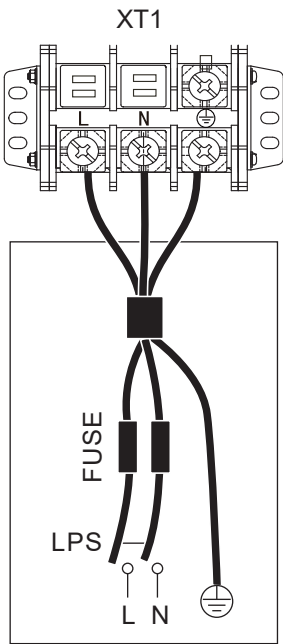

INDOOR UNIT
POWER SUPPLY
(Basic)

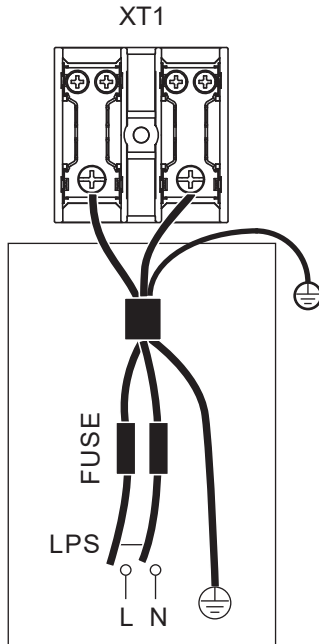

INDOOR UNIT
POWER SUPPLY
1-phase 3KW backup heater

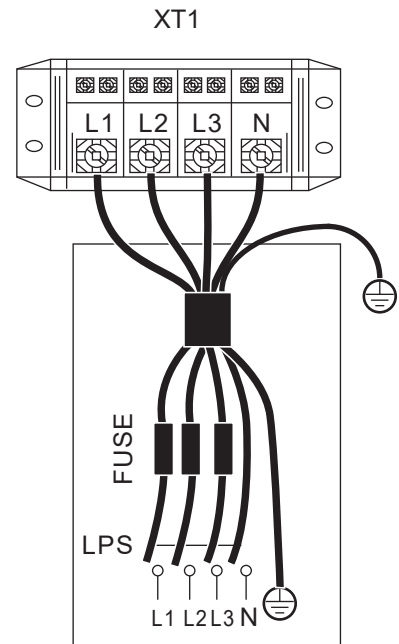

INDOOR UNIT
POWER SUPPLY
3-phase 3/6/9KW backup heater

Unit	Basic	3KW-1PH	3KW-3PH	6KW-3PH	9KW-3PH
Wiring size(mm ²)	1.5	4.0	2.5	4.0	4.0

- Stated values are maximum values (see electrical data for exact values).

⚠ CAUTION

When connecting to the power supply terminal, use the circular wiring terminal with the insulation casing (see Figure 8.1). Use power cord that conforms to the specifications and connect the power cord firmly. To prevent the cord from being pulled out by external force, make sure it is fixed securely.

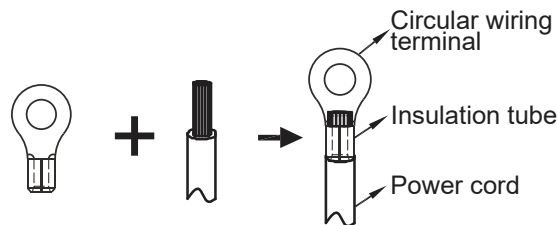
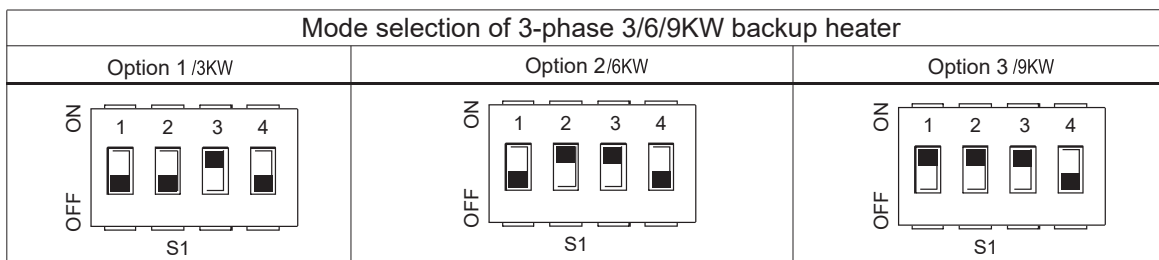

Figure 8.1

💡 NOTE

The ground fault circuit interrupter must be a high-speed type breaker of 30 mA (<0.1 s). Flexible cord must meet 60245IEC(H05VV-F) standards.



💡 NOTE

The default of backup heater is as option 3 (for 9kW backup heater). If 3kW or 6kW backup heater is needed, please ask professional installer to change the Dip switch S1 to option 1(for 3kW backup heater) or option 2(for 6kW backup heater), refer to 9.2.1 FUNCTION SETTING.

8.8.6 Connection for other components

Unit 4-16kw

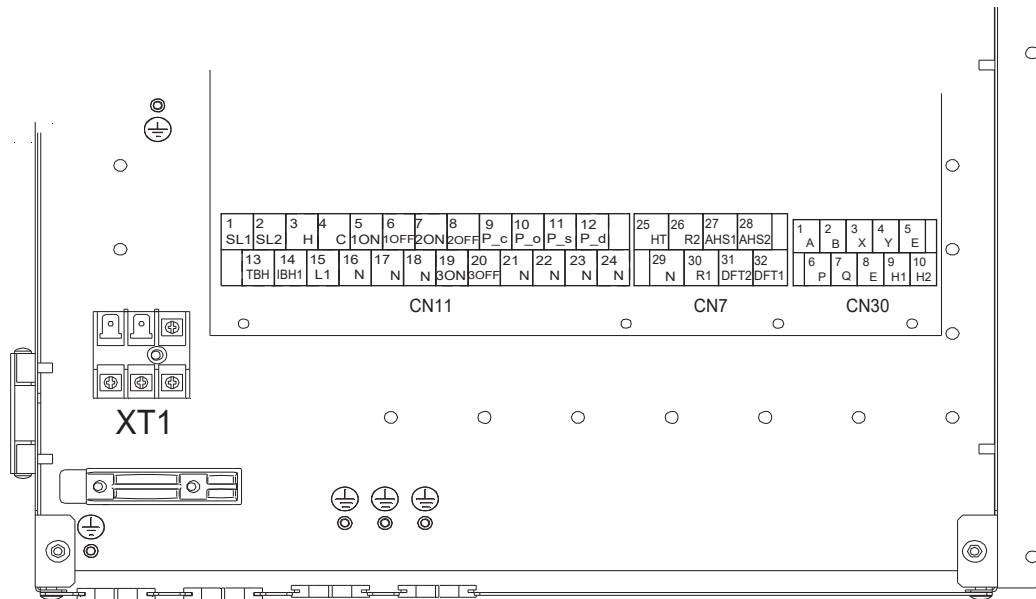

	Code	Print	Connect to
②	3 H 4 C	Room thermostat input (high voltage)	
	15 L1		
③	5 1ON 6 1OFF	SV1(3-way valve)	
	16 N		
④	7 2ON 8 2OFF	SV2(3-way valve)	
	17 N		
⑤	9 P_c 21 N	Pumpc(zone2 pump)	
	10 P_o 22 N		Outside circulation pump /zone1 pump
⑥	11 P_s 23 N	Solar energy pump	
	12 P_d 24 N		DHW pipe pump
⑨	13 TBH 16 N	Tank booster heater	
	14 IBH1 17 N		Internal backup heater 1
⑩	18 N 19 3ON	SV3(3-way valve)	
	20 3OFF		

	Code	Print	Connect to	
				①
5 E				
②	6 P 7 Q	Outdoor unit		
	③		9 H1 10 H2	

	Code	Print	Connect to
31 DFT2 32 DFT1	Defrost run		
②		25 HT 29 N	Antifreeze E-heating tape(external)
	③	27 AHS1 28 AHS2	

XT1	L	Indoor unit power supplier
	N	
	G	

Port provide the control signal to the load.Two kind of control signal port:

Type 1: Dry connector without voltage.

Type 2: Port provide the signal with 220V voltage. If the current of load is <0.2A, load can connect to the port directly.

If the current of load is $\geq 0.2A$, the AC contactor is required to connected for the load.

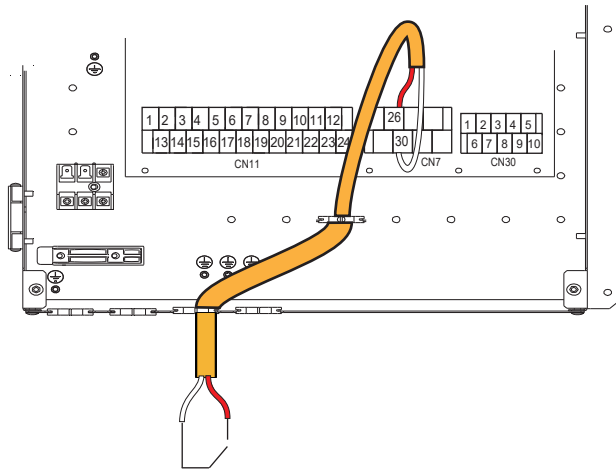

Type 1 Running

1) For solar energy input signal

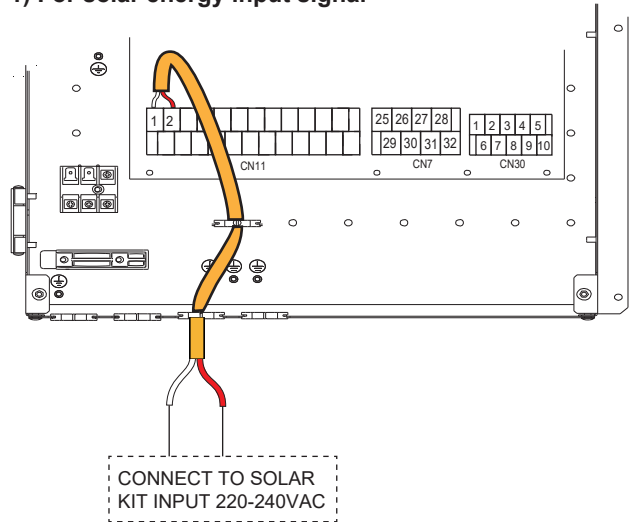

Voltage	220-240VAC
Maximum running current(A)	0.2
Wiring size(mm ²)	0.75

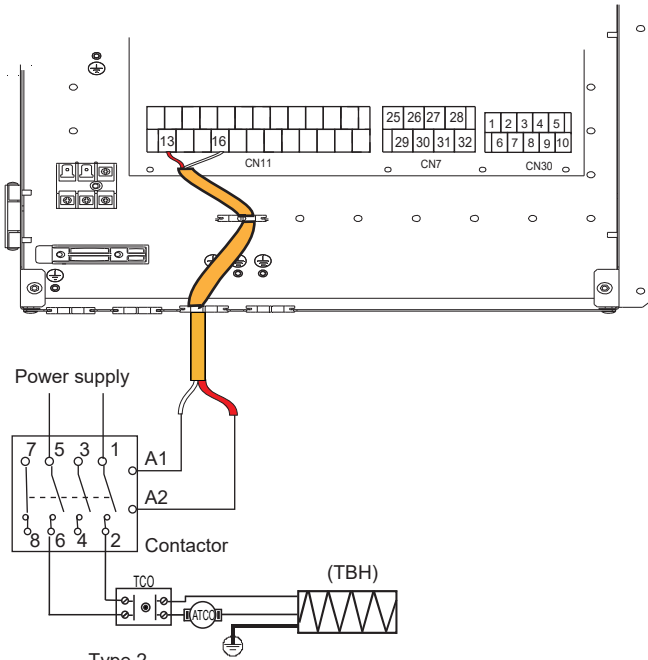

Type 2

Control signal port of indoor unit: The **CN11/CN7** contains terminals for solar energy, 3-way valve, pump, booster heater, etc.

The parts wiring is illustrated below:

2) For 3-way valve SV1、SV2 and SV3

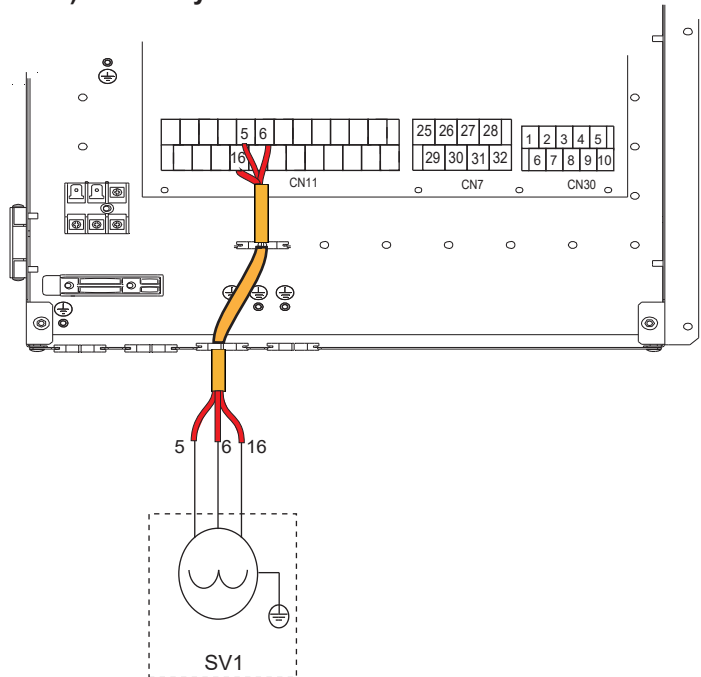

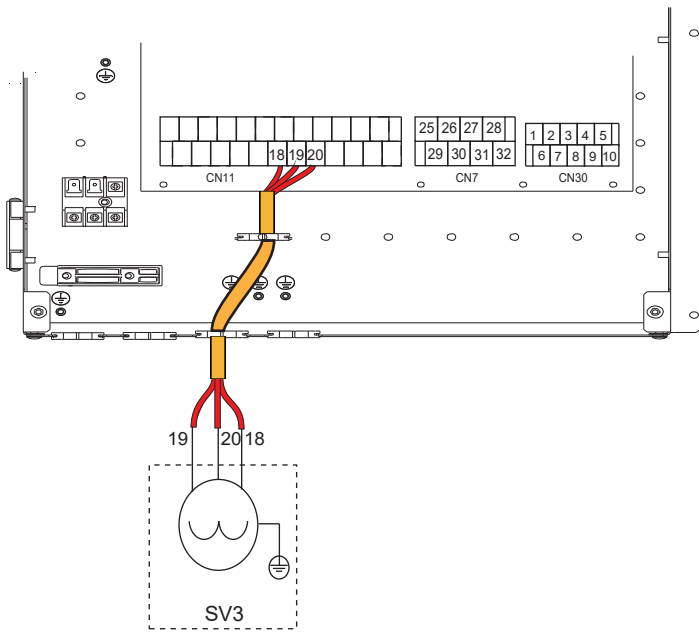
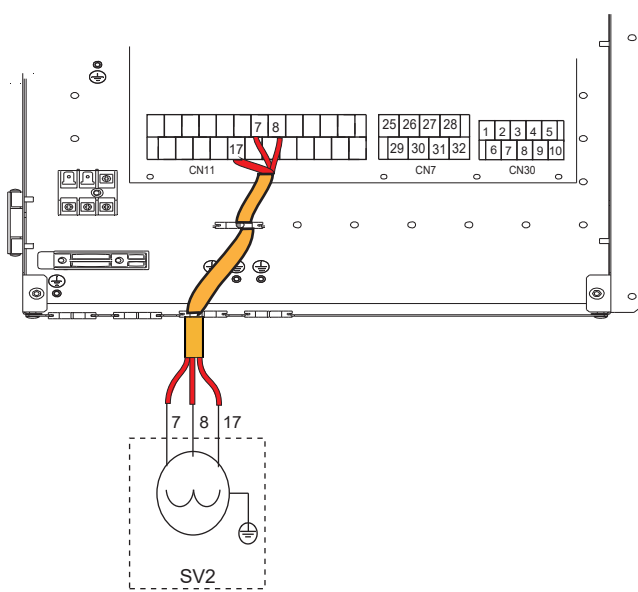

Voltage	220-240VAC
Maximum running current(A)	0.2
Wiring size(mm ²)	0.75
Control port signal type	Type 2

a) Procedure

- Connect the cable to the appropriate terminals as shown in the picture.
- Fix the cable reliably.

4) For remote shut down:

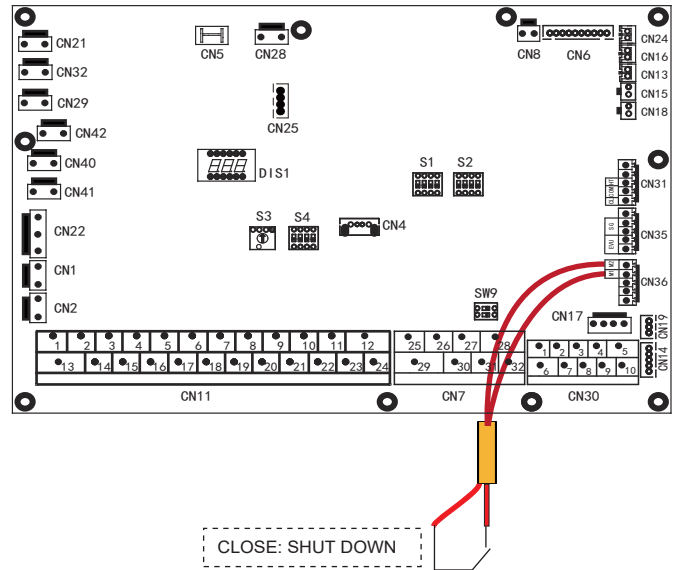

5) For Pumpc and DHW pipe pump :

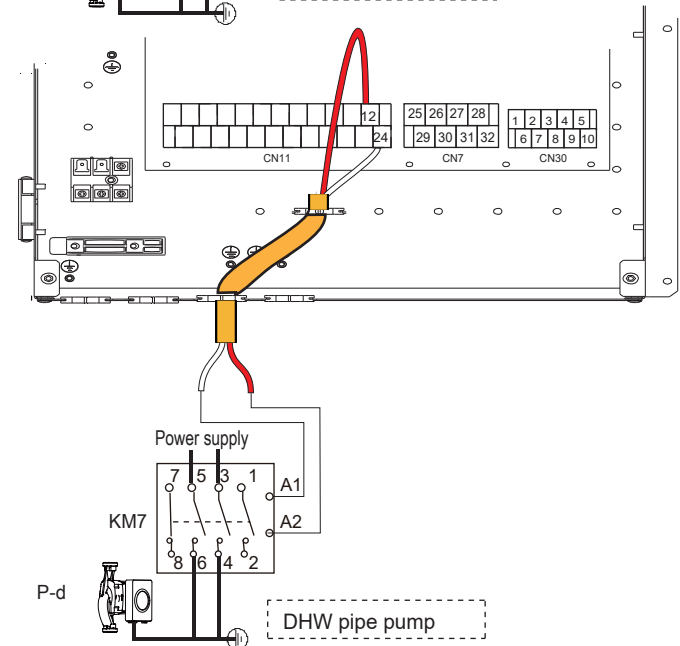
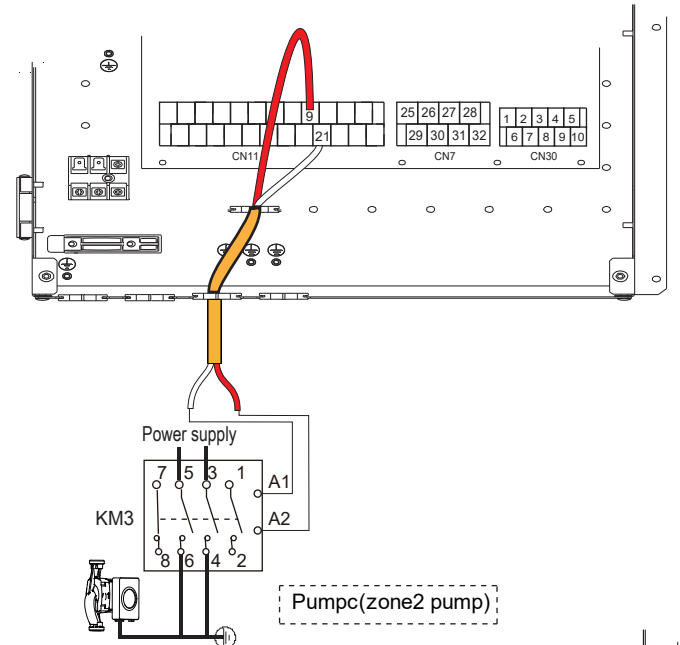

Voltage	220-240VAC
Maximum running current(A)	0.2
Wiring size(mm ²)	0.75
Control port signal type	Type 2

a) Procedure

- Connect the cable to the appropriate terminals as shown in the picture.
- Fix the cable reliably.

6) For room thermostat:

Room thermostat type 1(High voltage): "POWER IN" provide the working voltage to the RT, doesn't provide the voltage to the RT connector directly. Port "15 L1" provide the 220V voltage to the RT connector. Port "15 L1" connect from the unit main power supply port L of 1- phase power supply.

Room thermostat type 2(Low voltage) : "POWER IN" provide the working voltage to the RT

NOTE

There are two optional connect method depend on the room thermostat type.

Room thermostat type 1 (High voltage):

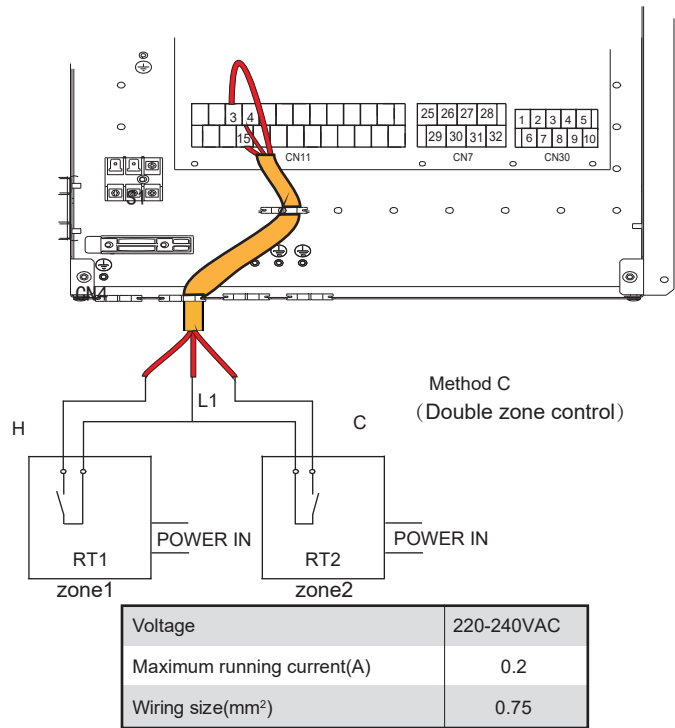
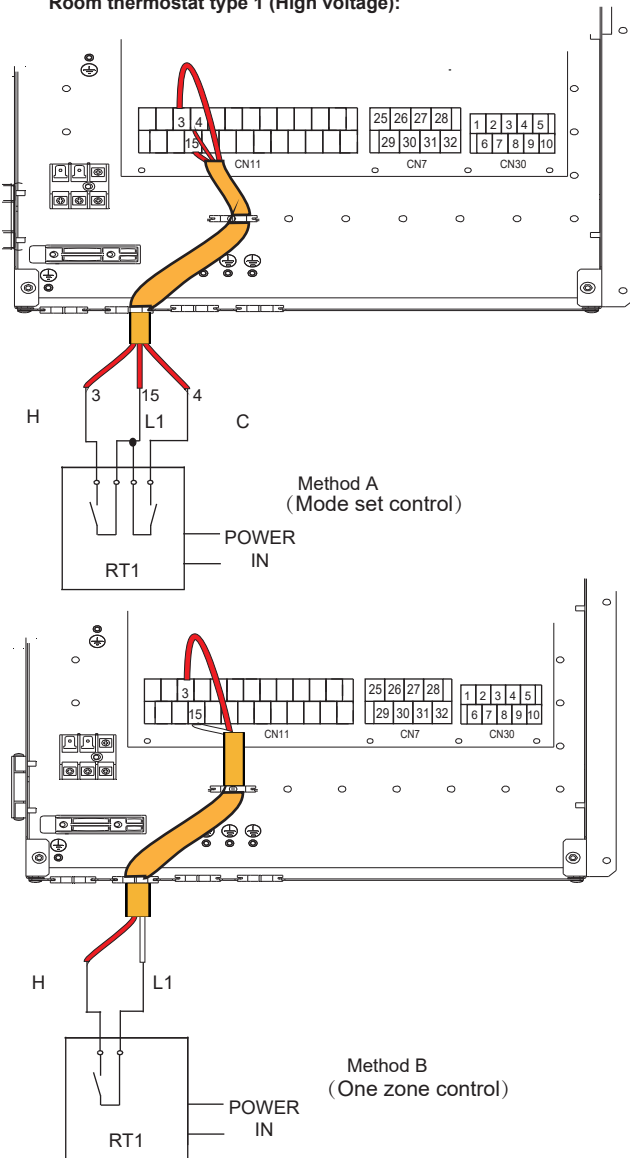

There are three methods for connecting the thermostat cable (as described in the picture above) and it depends on the application.

• Method A (Mode set control)

RT can control heating and cooling individually, like the controller for 4-pipe FCU. When the indoor unit is connected with the external temperature controller, user interface FOR SERVICEMAN set ROOM THERMOSTAT to MODE SET:

- A.1 When unit detect voltage is 230VAC between C and L1 , the unit operates in the cooling mode.
- A.2 When unit detect voltage is 230VAC between H and L1, the unit operates in the heating mode.
- A.3 When unit detect voltage is 0VAC for both side(C-L1, H-L1) the unit stop working for space heating or cooling.
- A.4 When unit detect voltage is 230VAC for both side(C-L1, H-L1) the unit working in cooling mode.

• Method B (One zone control)

RT provide the switch signal to unit. User interface FOR SERVICEMAN set ROOM THERMOSTAT to ONE ZONE:

- B.1 When unit detect voltage is 230VAC between H and L1, unit turns on.
- B.2 When unit detect voltage is 0VAC between H and L1, unit turns off.

• Method C (Double zone control)

Indoor unit is connected with two room thermostat, while user interface FOR SERVICEMAN set ROOM THERMOSTAT to DOUBLE ZONE:

- C.1 When unit detect voltage is 230VAC between H and L1 ,zone1 turns on.When unit detect voltage is 0VAC between H and L1, zone1 turns off.
- C.2 When unit detect voltage is 230VAC between C and L1, zone2 turns on according to climate temp curve. When unit detect voltage is 0V between C and L1, zone2 turns off.
- C.3 When H-L1 and C-L1 are detected as 0VAC, unit turns off.
- C.4 when H-L1 and C-L1 are detected as 230VAC, both zone1 and zone2 turn on.

Room thermostat type2 (Low voltage):

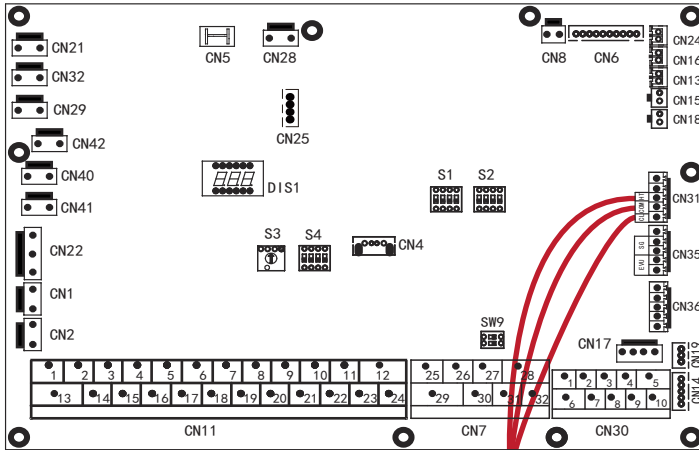

Method A
(Mode set control)

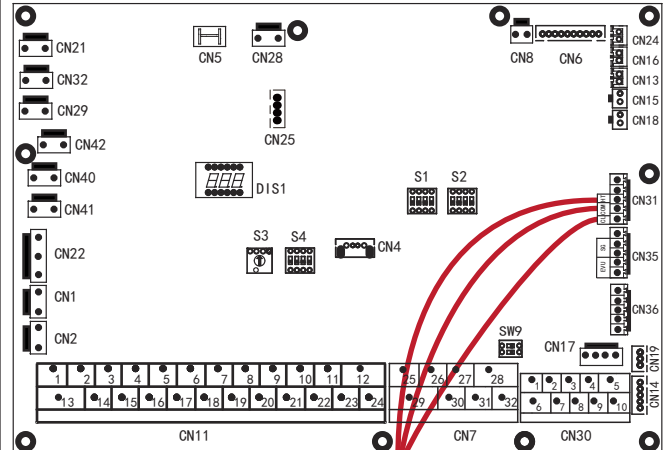
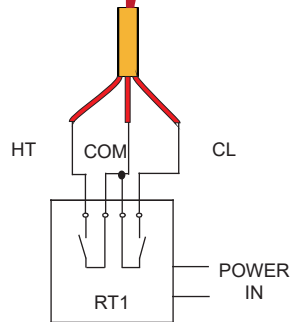

Method C
(Double zone control)

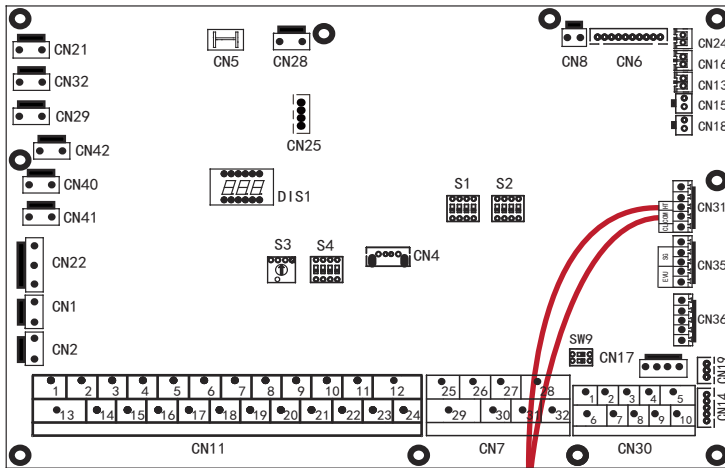
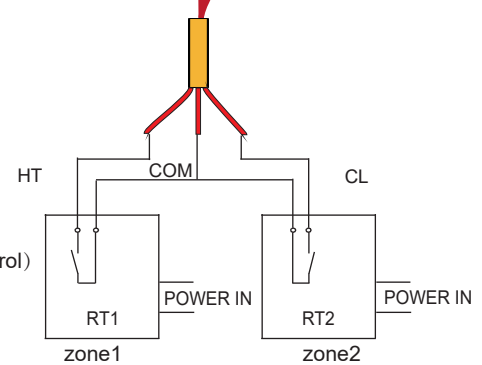

Method B
(One zone control)

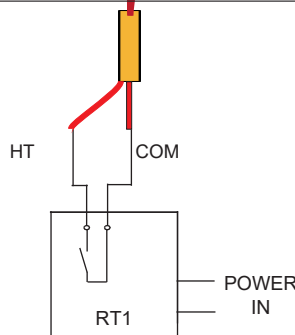

There are three methods for connecting the thermostat cable (as described in the picture above) and it depends on the application.

• **Method A** (Mode set control)

RT can control heating and cooling individually, like the controller for 4-pipe FCU. When the indoor unit is connected with the external temperature controller, user interface FOR SERVICEMAN set ROOM THERMOSTAT to MODE SET:

- A.1 When unit detect voltage is 12VDC between CL and COM ,the unit operates in the cooling mode.
- A.2 When unit detect voltage is 12VDC between HT and COM, the unit operates in the heating mode.
- A.3 When unit detect voltage is 0VDC for both side(CL-COM, HT-COM) the unit stop working for space heating or cooling.
- A.4 When unit detect voltage is 12VDC for both side(CL-COM, HT-COM) the unit working in cooling mode.

• **Method B** (One zone control)

RT provide the switch signal to unit. User interface FOR SERVICEMAN set ROOM THERMOSTAT to ONE ZONE:

- B.1 When unit detect voltage is 12VDC between HT and COM, unit turns on.
- B.2 When unit detect voltage is 0VDC between HT and COM, unit turns off.

• **Method C** (Double zone control)

Indoor unit is connected with two room thermostat, while user interface FOR SERVICEMAN set ROOM THERMOSTAT to DOUBLE ZONE:

- C.1 When unit detect voltage is 12VDC between HT and COM ,zone1 turn on. When unit detect voltage is 0VDC between HT and COM, zone1 turn off.

C.2 When unit detect voltage is 12VDC between CL and COM, zone2 turn on according to climate temp curve. When unit detect voltage is 0V between CL and COM, zone2 turn off.

C.3 When HT-COM and CL-COM are detected as 0VDC, unit turn off.

C.4 when HT-COM and CL-COM are detected as 12VDC, both zone1 and zone2 turn on.

NOTE

- The wiring of the thermostat should correspond to the settings of the user interface. Refer to **ROOM THERMOSTAT**.
- Power supply of machine and room thermostat must be connected to the same Neutral Line .
- When ROOM THERMOSTAT is not set to NON, the indoor temperature sensor Ta can't be set to valid
- Zone 2 can only operate in heating mode, When cooling mode is set on user interface and zone1 is OFF, "CL" in zone2 closes, system still keeps 'OFF'. While installation, the wiring of thermostats for zone1 and zone2 must be correct.

a) Procedure

- Connect the cable to the appropriate terminals as shown in the picture.
- Fix the cable with cable ties to the cable tie mountings to ensure stress relief.

7) For tank booster heater:

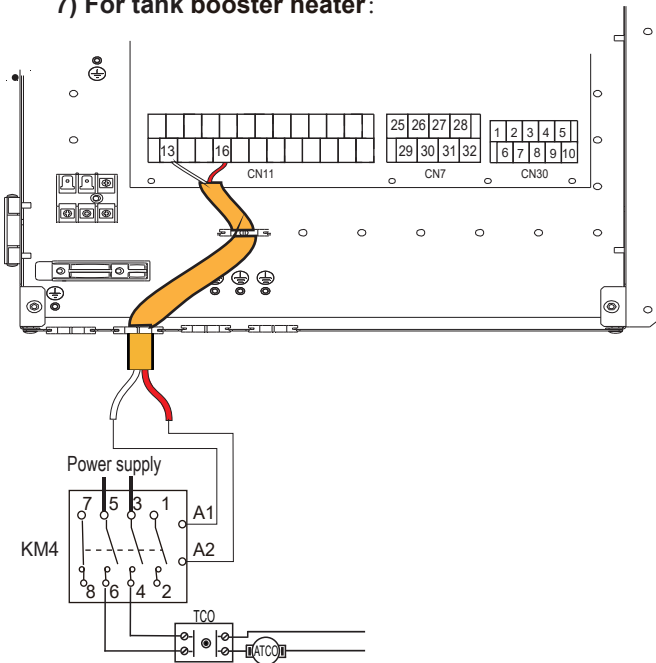

Voltage	220-240VAC
Maximum running current(A)	0.2
Wiring size(mm ²)	0.75
Control port signal type	Type 2

NOTE

The unit only sends an ON/OFF signal to the heater.

8) For additional heat source control:

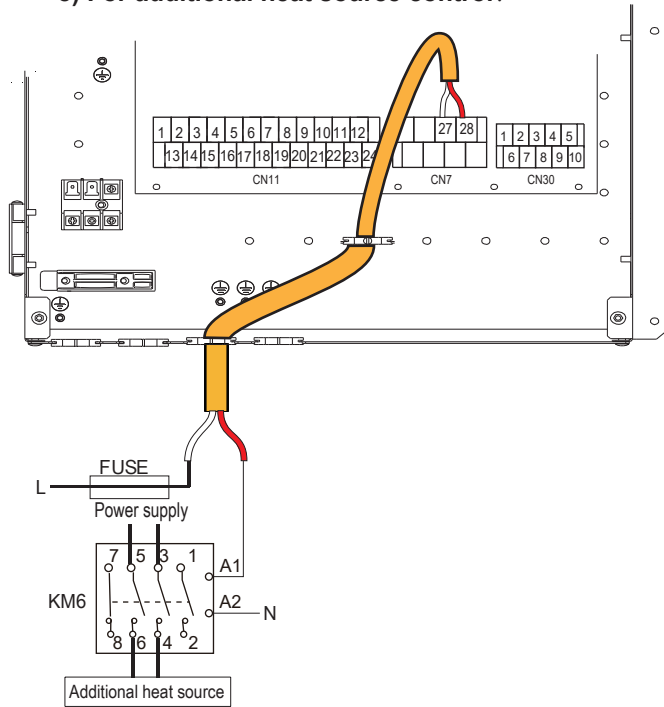

Voltage	220-240VAC
Maximum running current(A)	0.2
Wiring size(mm ²)	0.75
Control port signal type	Type 2

WARNING

This part only applies to Basic. For Customized, cause there is an interval backup heater in the unit, the indoor unit should not be connected to any additional heat source.

9) For defrosting signal output:

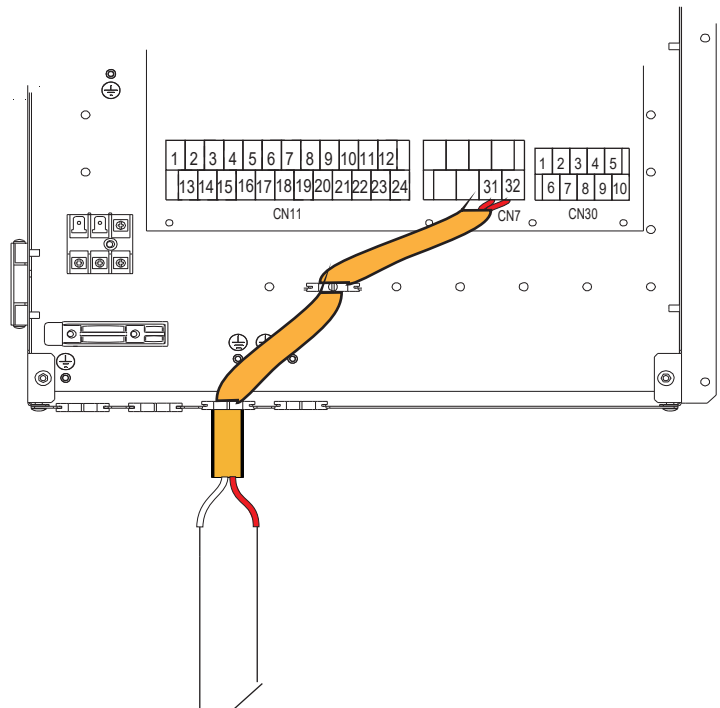

DEFROSTING PROMPT SIGNAL

Voltage	220-240VAC
Maximum running current(A)	0.2
Wiring size(mm ²)	0.75
Control port signal type	Type 1

10) For outside circulation pump P_o:

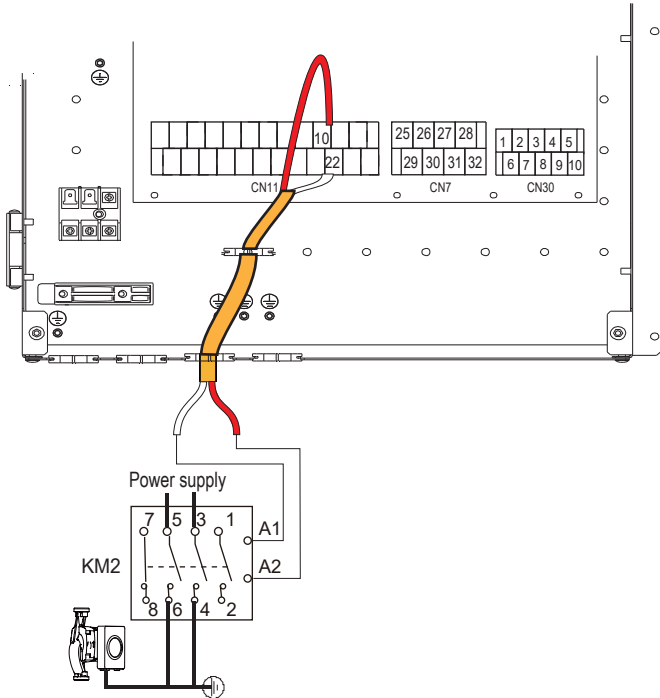

Voltage	220-240VAC
Maximum running current(A)	0.2
Wiring size(mm ²)	0.75
Control port signal type	Type 2

a) Procedure

- Connect the cable to the appropriate terminals as shown in the picture.
- Fix the cable with cable ties to the cable tie mountings to ensure stress relief.

11) For backup heater:

For standard indoor unit 60, 100, and 160, there is no internal backup heater inside the indoor unit, but the indoor unit can be connected to an external backup heater, as described in the picture below.

Voltage	220-240VAC
Maximum running current(A)	0.2
Wiring size(mm ²)	0.75
Control port signal type	Type 2

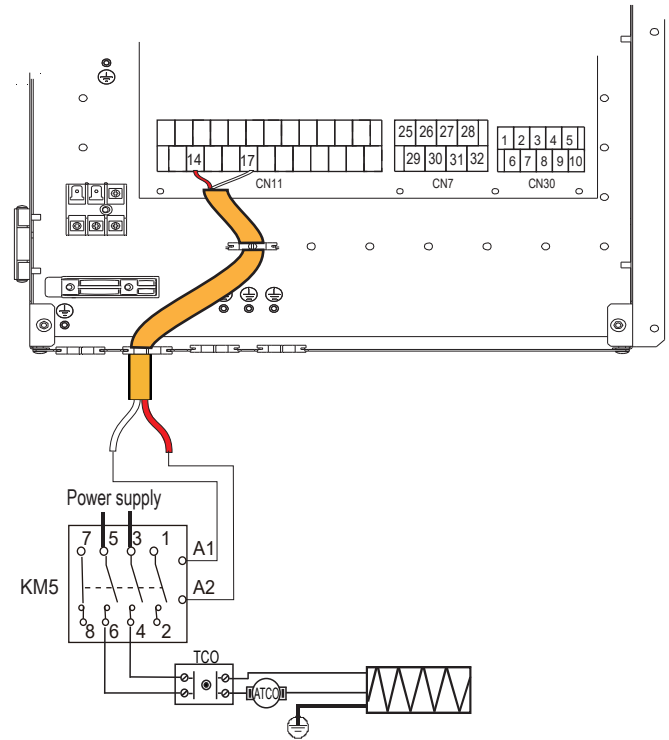

12) For smart grid:

The unit has smart grid function, there are two ports on PCB to connect SG signal and EVU signal as following:

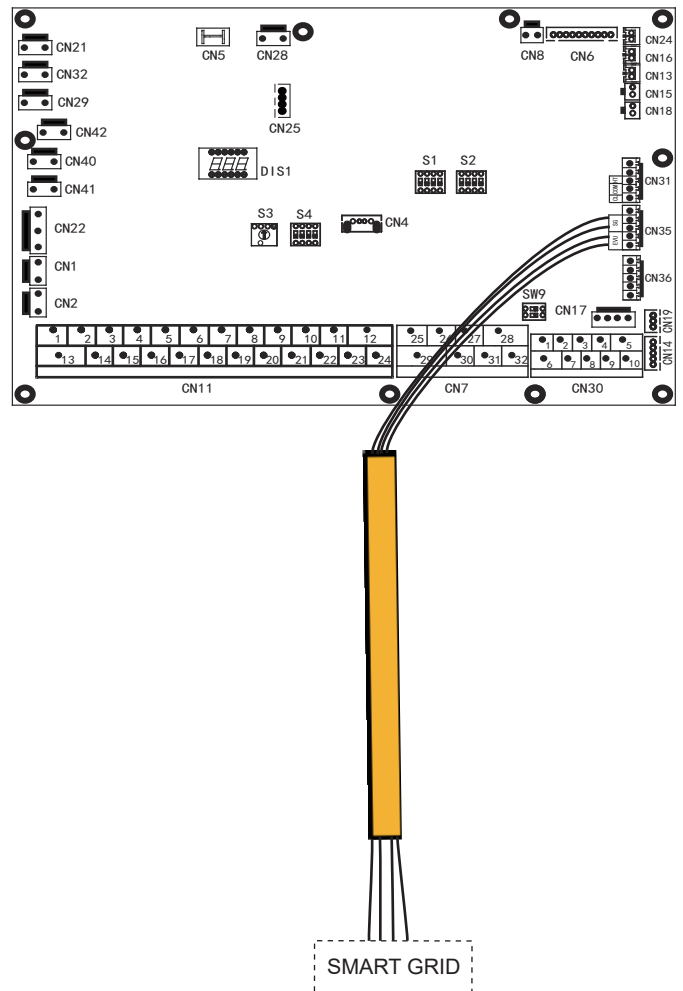

1. When EVU signal is on , and SG signal is on, as long as the DHW mode is set to be valid, heat pump will operate DHW mode priority and the DHW mode setting temperature will be change to 70 C . $T5 < 69 C$, the TBH is on, $T5 \geq 70 C$, the TBH is off.
2. When EVU signal is on , and SG signal is off, as long as the DHW mode is set to be valid and the mode is on, heat pump will operate DHW mode priority. $T5 < T5S-2$, the TBH is on, $T5 \geq T5S+3$, the TBH is off.
3. When EVU signal is off, and SG signal is on, the unit operates normally.
4. When EVU signal is off, and SG signal is off, the unit operates as below: The unit will not operate DHW mode, and the TBH is invalid, disinfect function is invalid. The max running time for cooling/heating is "SG RUNNING TIME", then unit will be off.

9 START-UP AND CONFIGURATION

The unit should be configured by the installer to match the installation environment (outdoor climate, installed options, etc.) and user expertise.

⚠ CAUTION

It is important that all information in this chapter is read sequentially by the installer and that the system is configured as applicable.

9.1 DIP switch settings overview

9.1.1 Function setting

DIP switch S1、 S2 and S4 is located on the indoor unit main control board (see "8.3.1 main control board of indoor unit") and allows configuration of additional heating source thermistor installation, the second inner backup heater installation, etc.

⚠ WARNING

Switch off the power supply before opening the switch box service panel and making any changes to the DIP switch settings.

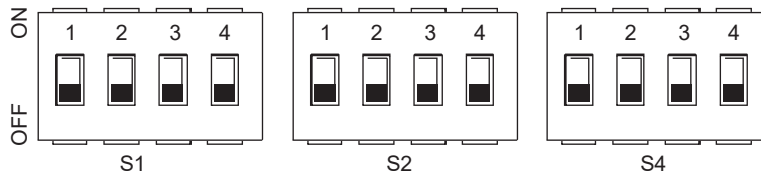

DIP switch	ON=1	OFF=0	Factory default	DIP switch	ON=1	OFF=0	Factory default	DIP switch	ON=1	OFF=0	Factory default		
S1	0/0=IBH(One-step control)	Refer to electrically controlled wiring diagram		S2	1	Start pumpo after 24 hours will be invalid	Refer to electrically controlled wiring diagram	S4	1	Reserved	Reserved	Refer to electrically controlled wiring diagram	
	1/2 0/1=IBH(Two-step control)				2	without TBH			with TBH	2	IBH for DHW =valid		IBH for DHW =invalid
	1/1=IBH(Three-step control)				3/4	0/0=pump 1 0/1=pump 2 1/0=pump 3 1/1=pump 4			3/4	Reserved			
	0/0=Without IBH and AHS 1/0=With IBH 0/1=With AHS for heat mode 1/1=With AHS for heat mode and DHW mode												

9.2 Initial start-up at low outdoor ambient temperature

During initial start-up and when water temperature is low, it is important that the water is heated gradually. Failure to do so may result in concrete floors cracking due to rapid temperature change. Please contact the responsible cast concrete building contractor for further details.

To do so, the lowest water flow set temperature can be decreased to a value between 25°C and 35°C by adjusting the FOR SERVICEMAN. Refer to **SPECIAL FUNCTION**.

9.3 Pre-operation checks

Checks before initial start-up.

DANGER

Switch off the power supply before making any connections.

After the installation of the unit, check the following before switching on the circuit breaker:

- **Field wiring:** Make sure that the field wiring between the local supply panel and unit and valves (when applicable), unit and room thermostat (when applicable), unit and domestic hot water tank, and unit and backup heater kit have been connected according to the instructions described in the chapter **8.8 "Field wiring"**, according to the wiring diagrams and to local laws and regulations.
- **Fuses, circuit breakers, or protection devices** Check that the fuses or the locally installed protection devices are of the size and type specified in **13 "Technical specifications"**. Make sure that no fuses or protection devices have been bypassed.
- **Backup heater circuit breaker:** Do not forget to turn on the backup heater circuit breaker in the switchbox (it depends on the backup heater type). Refer to the wiring diagram.
- **Booster heater circuit breaker:** Do not forget to turn on the booster heater circuit breaker (applies only to units with optional domestic hot water tank installed).
- **Ground wiring:** Make sure that the ground wires have been connected properly and that the ground terminals are tightened.
- **Internal wiring:** Visually check the switch box for loose connections or damaged electrical components.
- **Mounting:** Check that the unit is properly mounted, to avoid abnormal noises and vibrations when starting up the unit.
- **Damaged equipment:** Check the inside of the unit for damaged components or squeezed pipes.
- **Refrigerant leak:** Check the inside of the unit for refrigerant leakage. If there is a refrigerant leak, call your local dealer.
- **Power supply voltage:** Check the power supply voltage on the local supply panel. The voltage must correspond to the voltage on the identification label of the unit.
- **Air purge valve:** Make sure the air purge valve is open (at least 2 turns).
- **Shut-off valves:** Make sure that the shut-off valves are fully open.

9.4 Setting the pump

The pump is controlled via a digital low-voltage pulse-width modulation signal which means that the speed of rotation depends on the input signal. The speed changes as a function of the input profile.

The relationships between the head and the water flow rate, the PMW Return and the water flow rate are shown in the graph below.

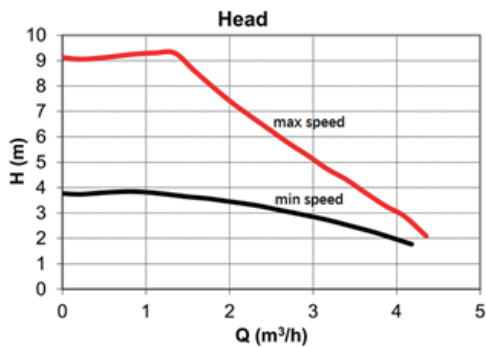

Area of regulation is included in between the max speed curve and the min speed curve.

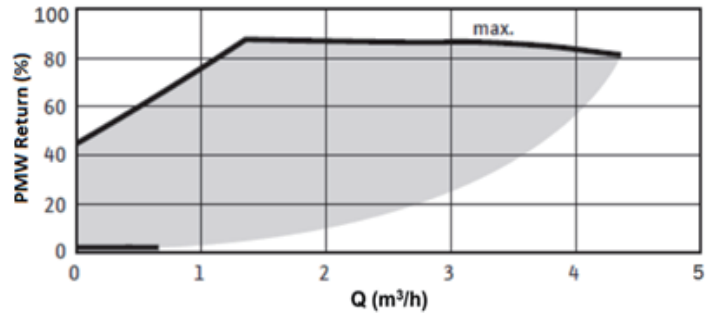

The internal pump maintains maximum output, the indoor unit can provide the head and flow:

Available external static pressure VS Flow rate

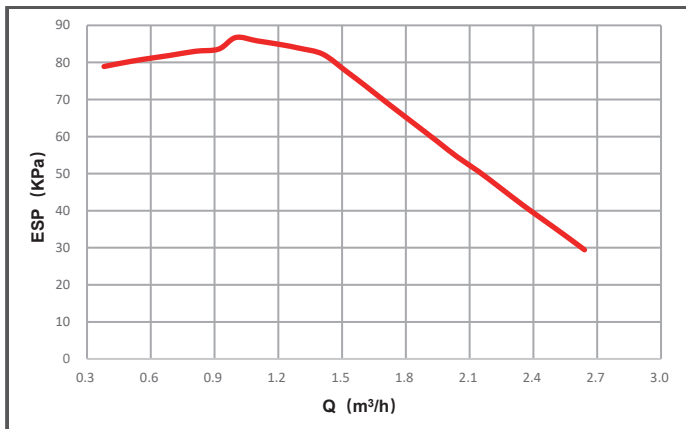

Indoor unit 60, 100

Available external static pressure VS Flow rate

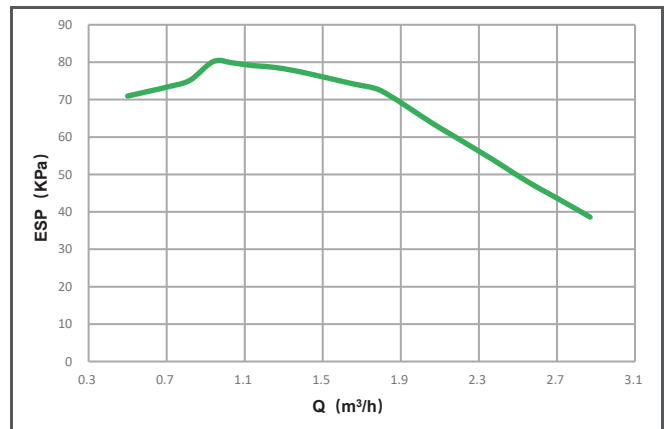

Indoor unit 160

⚠ CAUTION

If the valves are at the incorrect position, the circulation pump will be damaged.

⚠ DANGER

If it's necessary to check the running status of the pump when unit power on, please do not touch the internal electronic control box components to avoid electric shock.

Failure diagnosis at first installation

- If nothing is displayed on the user interface, it is necessary to check for any of the following abnormalities before diagnosing possible error codes.
 - Disconnection or wiring error (between power supply and unit and between unit and user interface).
 - The fuse on the PCB may be broken.
- If the user interface shows "E8" or "E0" as an error code, there is a possibility that there is air in the system, or the water level in the system is less than the required minimum.
- If the error code E2 is displayed on the user interface, check the wiring between the user interface and unit.

More error code and failure causes can be found in **12.4 "Error codes"**.

9.5 Field settings

The unit should be configured to match the installation environment (outdoor climate, installed options, etc.) and user demand. A number of field settings are available. These settings are accessible and programmable through "FOR SERVICEMAN" in user interface.

Powering on the unit

When power on the unit, "1%~99%" is displayed on the user interface during initialization. During this process the user interface cannot be operated.

Procedure

To change one or more field settings, proceed as follows.

NOTE

Temperature values displayed on the wired controller (user interface) are in °C.

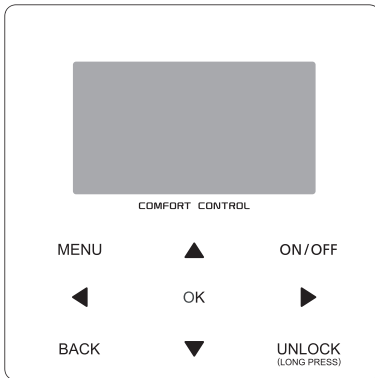

Keys	Function
MENU	• Go to the menu structure(on the home page)
◀▶▼▲	• Navigate the cursor on the display • Navigate in the menu structure • Adjust settings
ON/OFF	• Turn on/off the space heating/cooling operation or DHW mode • Turn on/or off functions in the menu structure
BACK	• Come back to the up level
UNLOCK	• Long press for unlock /lock the controller • Unlock /lock some functions such as "DHW temperature adjusting"
OK	• Go to the next step when programming a schedule in the menu structure; and confirm a selection to enter in the submenu of the menu structure.

About FOR SERVICEMAN

"FOR SERVICEMAN" is designed for the installer to set the parameters.

- Setting the composition of equipment.
- Setting the parameters.

How to go to FOR SERVICEMAN

Go to MENU> FOR SERVICEMAN. Press OK:

FOR SERVICEMAN	
Please input the password:	
0 0 0	
OK ENTER	ADJUST

Press ◀ ▶ to navigate and press ▼ ▲ to adjust the numerical value. Press OK. The password is 234, the following pages will be displayed after putting the password:

FOR SERVICEMAN	1/3
1. DHW MODE SETTING	
2. COOL MODE SETTING	
3. HEAT MODE SETTING	
4. AUTO MODE SETTING	
5. TEMP.TYPE SETTING	
6. ROOM THERMOSTAT	
OK ENTER	

FOR SERVICEMAN	2/3
7. OTHER HEATING SOURCE	
8. HOLIDAY AWAY MODE SET	
9. SERVICE CALL SETTING	
10. RESTORE FACTORY SETTINGS	
11. TEST RUN	
12. SPECIAL FUNCTION	
OK ENTER	

FOR SERVICEMAN	3/3
13. AUTO RESTART	
14. POWER INPUT LIMITATION	
15. INPUT DEFINE	
16. CASCADE SET	
17. HMI ADDRESS SET	
OK ENTER	

Press ▼ ▲ to scroll and use "OK" to enter submenu.

9.5.1 DHW MODE SETTING

DHW = domestic hot water

Go to MENU> FOR SERVICEMAN> 1.DHW MODE SETTING. Press OK. The following pages will be displayed:

1 DHW MODE SETTING	1/5
1.1 DHW MODE	YES
1.2 DISINFECT	YES
1.3 DHW PRIORITY	YES
1.4 DHW PUMP	YES
1.5 DHW PRIORITY TIME SET	NON
ADJUST	

1 DHW MODE SETTING	2/5
1.6 dT5_ON	5 °C
1.7 dT1S5	10 °C
1.8 T4DHWMAX	43 °C
1.9 T4DHWMIN	-10 °C
1.10 t_INTERVAL_DHW	5 MIN
ADJUST	

1 DHW MODE SETTING	3/5
1.11 dT5_TBH_OFF	5 °C
1.12 T4_TBH_ON	5 °C
1.13 t_TBH_DELAY	30 MIN
1.14 T5S_DI	65 °C
1.15 t_DI HIGHTEMP.	15MIN
ADJUST	

1 DHW MODE SETTING	4/5
1.16 t_DI_MAX	210 MIN
1.17 t_DHWHP_RESTRICT	30 MIN
1.18 t_DHWHP_MAX	120 MIN
1.19 DHWPUMP TIME RUN	YES
1.20 PUMP RUNNING TIME	5 MIN
ADJUST	

1 DHW MODE SETTING	5/5
1.21 DHW PUMP DI RUN	NON
ADJUST	

9.5.2 COOL MODE SETTING

Go to MENU> FOR SERVICEMAN> 2.COOL MODE SETTING. Press OK.

The following pages will be displayed:

2 COOL MODE SETTING	1/3
2.1 COOL MODE	YES
2.2 t_T4_FRESH_C	2.0HRS
2.3 T4CMAX	43°C
2.4 T4CMIN	20°C
2.5 dT1SC	5°C
ADJUST	

2 COOL MODE SETTING	2/3
2.6 dTSC	2°C
2.7 t_INTERVAL_C	5MIN
2.8 T1SetC1	10°C
2.9 T1SetC2	16°C
2.10 T4C1	35°C
ADJUST	

2 COOL MODE SETTING	3/3
2.11 T4C2	25°C
2.12 ZONE1 C-EMISSION	FCU
2.13 ZONE2 C-EMISSION	FLH
ADJUST	

9.5.3 HEAT MODE SETTING

Go to MENU>FOR SERVICEMAN> 3.HEAT MODE SETTING. Press OK. The following pages will be displayed:

3 HEAT MODE SETTING	1/3
3.1 HEAT MODE	YES
3.2 t_T4_FRESH_H	2.0HRS
3.3 T4HMAX	16°C
3.4 T4HMIN	-15°C
3.5 dT1SH	5°C
ADJUST	

3 HEAT MODE SETTING	2/3
3.6 dTSH	2°C
3.7 t_INTERVAL_H	5MIN
3.8 T1SetH1	35°C
3.9 T1SetH2	28°C
3.10 T4H1	-5°C
ADJUST	

3 HEAT MODE SETTING	3/3
3.11 T4H2	7°C
3.12 ZONE1 H-EMISSION	RAD.
3.13 ZONE2 H-EMISSION	FLH
3.14 t_DELAY_PUMP	2MIN
ADJUST	

9.5.4 AUTO MODE SETTING

Go to MENU> FOR SERVICEMAN> 4.AUTO MODE SETTING. Press OK, the following page will be displayed.

4 AUTO. MODE SETTING	
4.1 T4AUTOCMIN	25°C
4.2 T4AUTOHMAX	17°C
ADJUST	

9.5.5 TEMP. TYPE SETTING

About TEMP. TYPE SETTING

The TEMP. TYPE SETTING is used for selecting whether the water flow temperature or room temperature is used to control the ON/OFF of the heat pump.



When ROOM TEMP. is enabled, the target water flow temperature will be calculated from climate-related curves .

How to enter the TEMP. TYPE SETTING



Go to MENU> FOR SERVICEMAN> 5.TEMP. TYPE SETTING. Press OK. The following page will be displayed:

5 TEMP. TYPE SETTING	
5.1 WATER FLOW TEMP.	YES
5.2 ROOM TEMP.	NON
5.3 DOUBLE ZONE	NON
ADJUST	

If you only set WATER FLOW TEMP. to YES, or only set ROOM TEMP. to YES, The following pages will be displayed.







01-01-2018	23:59	13°
	ON	
Δ 35 °C		38 °C

only WATER FLOW TEMP. YES

01-01-2018	23:59	13°
	ON	
23.5 °C		38

only ROOM TEMP. YES

If you set WATER FLOW TEMP. and ROOM TEMP. to YES, meanwhile set DOUBLE ZONE to NON or YES, the following pages will be displayed.

01-01-2018	23:59	13°	01-01-2018	23:59	13°
	ON			ON	
Δ 35 °C		38 °C	23,5 °C		







Homepage (zone 1)

Addition page (zone 2)

(Double zone is effective)

In this case, the setting value of zone 1 is T1S, the setting value of zone 2 is T1S2 (The corresponding T1S2 is calculated according to the climate related curves.)

If you set DOUBLE ZONE to YES and set ROOM TEMP. to NON, meanwhile set WATER FLOW TEMP. to YES or NON, the following pages will be displayed.

01-01-2018	23:59	13°	01-01-2018	23:59	13°
	ON			ON	
Δ 35 °C		38 °C	Δ 35 °C		

Homepage (zone 1)

Addition page (zone 2)

In this case, the setting value of zone 1 is T1S, the setting value of zone 2 is T1S2.

If you set DOUBLE ZONE and ROOM TEMP. to YES, meanwhile set WATER FLOW TEMP. to YES or NON, the following page will be displayed.

01-01-2018 23:59 ↑13°		01-01-2018 23:59 ↑13°	
	ON		ON
35 °C		38 °C	
		23.5 °C	

Homepage (zone 1)

Addition page (zone 2)

(Double zone is effective)

In this case, the setting value of zone 1 is T1S, the setting value of zone 2 is T1S2 (The corresponding T1S2 is calculated according to the climate related curves.)

9.5.6 ROOM THERMOSTAT

About ROOM THERMOSTAT

The ROOM THERMOSTAT is used to set whether the room thermostat is available.

How to set the ROOM THERMOSTAT

Go to MENU> FOR SERVICEMAN> 6.ROOM THERMOSTAT. Press OK. The following page will be displayed:

6 ROOM THERMOSTAT	
6.1 ROOM THERMOSTAT	NON
ADJUST	

NOTE

ROOM THERMOSTAT = NON, no room thermostat.

ROOM THERMOSTAT = MODE SET, the wiring of room thermostat should follow method A.

ROOM THERMOSTAT=ONE ZONE, the wiring of room thermostat should follow method B.

ROOM THERMOSTAT=DOUBLE ZONE, the wiring of room thermostat should follow method C (refer to 8.8.6 "Connection for other components/For room thermostat")

9.5.7 Other HEATING SOURCE

The OTHER HEATING SOURCE is used to set the parameters of the backup heater, additional heating sources and solar energy kit.

Go to MENU> FOR SERVICEMAN> 7.OTHER HEATING SOURCE, Press OK. The following page will be displayed:

7 OTHER HEATING SOURCE 1/2	
7.1 dT1_IBH_ON	5°C
7.2 t_IBH_DELAY	30MIN
7.3 T4_IBH_ON	-5°C
7.4 dT1_AHS_ON	5°C
7.5 t_AHS_DELAY	30MIN
ADJUST	

7 OTHER HEATING SOURCE 2/2	
7.6 T4_AHS_ON	5°C
7.7 IBH LOCATE	PIPE LOOP
7.8 P_IBH1	0.0kW
7.9 P_IBH2	0.0kW
7.10 P_TBH	2.0kW
ADJUST	

9.5.8 HOLIDAY AWAY SETTING

The HOLIDAY AWAY SETTING is used to set the outlet water temperature to prevent freezing when away for holiday.

Go to MENU> FOR SERVICEMAN> 8.HOLIDAY AWAY SETTING. Press OK. The following page will be displayed:

8 HOLIDAY AWAY SETTING	
8.1 T1S_H.A. H	20°C
8.2 T5S_H.A. DHW	20°C
ADJUST	

9.5.9 SERVICE CALL SETTING

The installers can set the phone number of the local dealer in SERVICE CALL SETTING. If the unit doesn't work properly, call this number for help.

Go to MENU> FOR SERVICEMAN>SERVICE CALL. Press OK. The following page will be displayed:

9 SERVICE CALL SETTING	
PHONE NO.	*****
MOBILE NO.	*****
OK CONFIRM	ADJUST

Press ▼ ▲ to scroll and set the phone number. The maximum length of the phone number is 13 digits, if the length of phone number is short than 12, please input ■, as shown below:

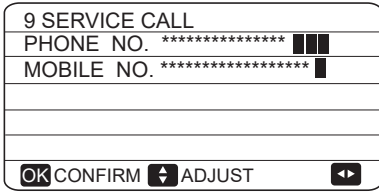

The number displayed on the user interface is the phone number of your local dealer.

9.5.10 RESTORE FACTORY SETTINGS

The RESTORE FACTORY SETTING is used to restore all the parameters set in the user interface to the factory setting.

Go to MENU> FOR SERVICEMAN> 10.RESTORE FACTORY SETTINGS. Press OK. The following page will be displayed:

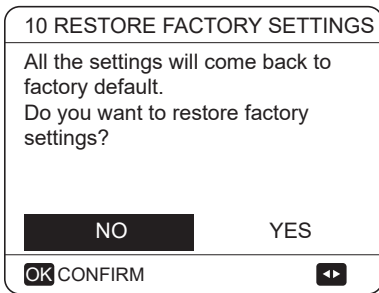

Press ◀ ▶ to scroll the cursor to YES and press OK. The following page will be displayed:

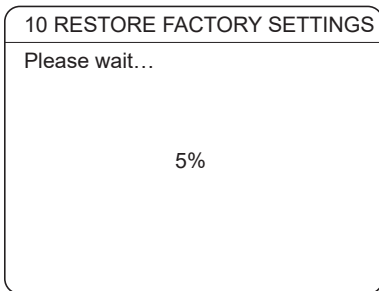

After a few seconds, all the parameters set in the user interface will be restored to factory settings.

9.5.11 TEST RUN

TEST RUN is used to check correct operation of the valves, air purge, circulation pump operation, cooling, heating and domestic water heating.

Go to MENU> FOR SERVICEMAN> 11.TEST RUN. Press OK. The following page will be displayed:

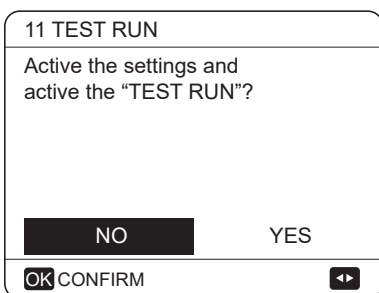

If YES is selected, the following pages will be displayed:

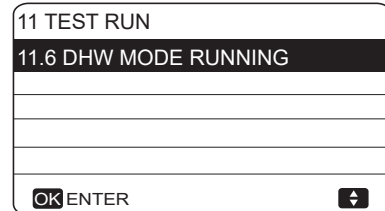
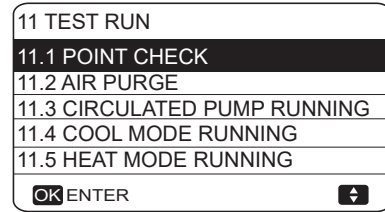

If POINT CHECK is selected, the following pages will be displayed:

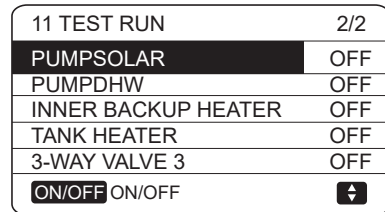
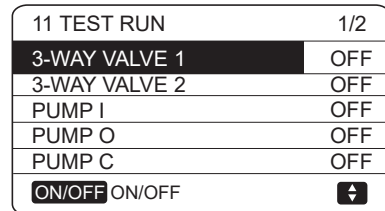

Press ▼ ▲ to scroll to the components you want to check and press ON/OFF. For example, when 3-way valve is selected and ON/OFF is pressed, if the 3-way valve is open/close, then the operation of 3-way valve is normal, and so are other components.

⚠ **CAUTION**

Before the point check, make sure the tank and the water system is filled with water, and air is expelled, or it may cause the pump or backup heater burn out.

If you select AIR PURGE and OK is pressed, the following page will be displayed :

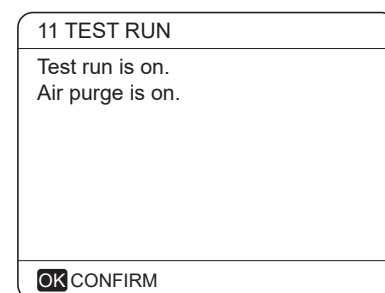

When in air purge mode, SV1 will open, SV2 will close. 60s later the pump in the unit (PUMPI) will operate for 10min during which the flow switch will not work. After the pump stops, the SV1 will close and the SV2 will open. 60s later both the PUMPI and PUMPO will operate until the next command is received.

When CIRCULATION PUMP RUNNING is selected, the following page will be displayed:

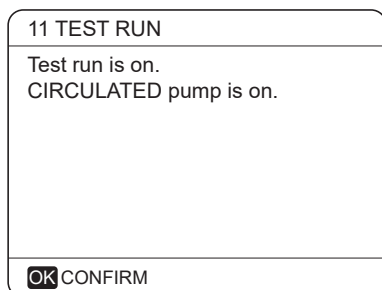

When circulation pump running is turned on, all running components will stop. 60 seconds later, the SV1 will open, the SV2 will close, 60 seconds later PUMPI will operate. 30s later, if the flow switch checked normal flow, PUMPI will operate for 3min, after the pump stops 60 seconds, the SV1 will close and the SV2 will open. 60s later the both PUMPI and PUMPO will operate, 2 mins later, the flow switch will check the water flow. If the flow switch closes for 15s, PUMPI and PUMPO will operate until the next command is received.

When the COOL MODE RUNNING is selected, the following page will be displayed:

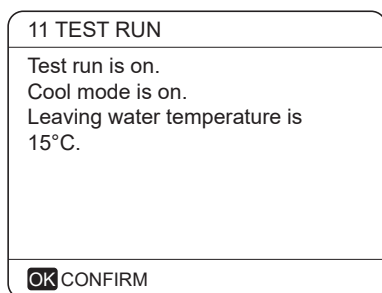

During COOL MODE test running, the default target outlet water temperature is 7°C. The unit will operate until the water temperature drops to a certain value or the next command is received.

When the HEAT MODE RUNNING is selected, the following page will be displayed:

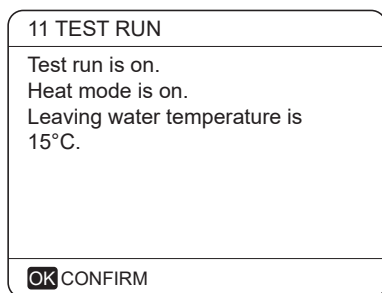

During HEAT MODE test running, the default target outlet water temperature is 35°C. The IBH (internal backup heater) will turn on after the compressor runs for 10 min. After the IBH runs for 3 minutes, the IBH will turn off, the heat pump will operate until the water temperature increase to a certain value or the next command is received.

When the DHW MODE RUNNING is selected, the following page will be displayed:

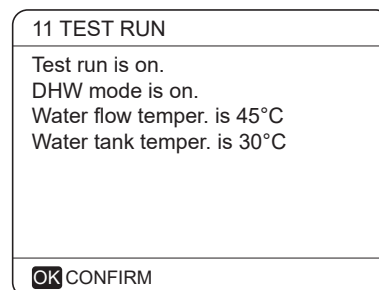

During DHW MODE test running, the default target temperature of the domestic water is 55°C. The TBH (tank boost heater) will turn on after the compressor runs for 10min. The TBH will turn off 3 minutes later, the heat pump will operate until the water temperature increase to a certain value or the next command is received.

During test run, all buttons except OK are invalid. If you want to turn off the test run, please press OK. For example, when the unit is in air purge mode, after you press OK, the following page will be displayed:

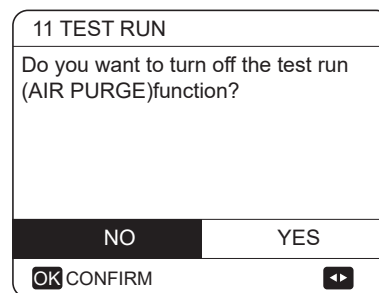

Press ◀ ▶ to scroll the cursor to YES and press OK. The test run will turn off.

9.5.12 SPECIAL FUNCTION

When it is in special function modes, the wired controller can not operate, the page do not return to the homepage, and the screen showed the page that special function runs, the wired controller do not locked.

NOTE

During special function operating other functions (WEEKLY SCHEDULE/TIMER , HOLIDAY AWAY, HOLIDAY HOME) can't be used.

Go to MENU> FOR SERVICEMAN> 12.SPECIAL FUNCTION.

Before floor heating, if a large amount of water remains on the floor, the floor may be warped or even rupture during floor heating operation, in order to protect the floor, floor drying is necessary, during which the temperature of the floor should be increased gradually.

12 SPECIAL FUNCTION	
Active the settings and active the "SPECIAL FUNCTION"?	
NO	YES
OK CONFIRM	

12 SPECIAL FUNCTION	
12.1 PREHEATING FOR FLOOR	
12.2 FLOOR DRYING UP	
OK ENTER	

Press ▼ ▲ to scroll and press OK to enter.

During first operation of the unit, air may remain in the water system which can cause malfunctions during operation. It is necessary to run the air purge function to release the air (make sure the air purge valve is open).

If PREHEATING FOR FLOOR is selected, after press OK, the following page will be displayed:

12.1 PREHEATING FOR FLOOR	
T1S	30°C
t_fristFH	72 HOURS
ENTER	EXIT
ADJUST	

When the cursor is on OPERATE PREHEATING FOR FLOOR, Use ◀ ▶ to scroll to YES and press OK. The following page will be displayed:

12.1 PREHEATING FOR FLOOR	
Preheat for floor is running for 25 minutes. Water flow temperature is 20°C.	
OK CONFIRM	

During preheating for floor, all the buttons except OK are invalid. If you want to turn off the preheating for floor, please press OK.

The following page will be displayed:

12.1 PREHEATING FOR FLOOR	
Do you want to turn off the preheating for floor function?	
NO	YES
OK CONFIRM	

Use ◀ ▶ to scroll the cursor to YES and press OK, the preheating for floor will turn off.

The operation of the unit during preheating for floor described in the picture below:

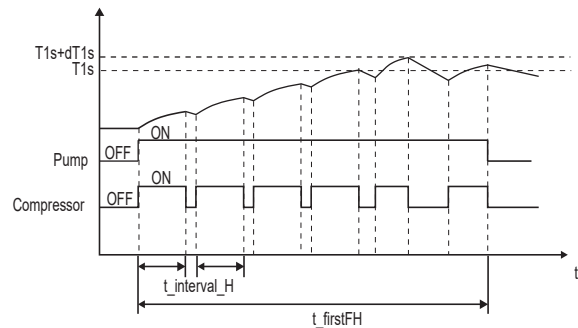

If FLOOR DRYING UP is selected, after press OK, the following pages will be displayed:

12.2 FLOOR DRYING UP	
WARM UP TIME(t_DRYUP)	8 days
KEEP TIME(t_HIGHPEAK)	5 days
TEMP. DOWN TIME(t_DRYDOWN)	5 days
PEAK TEMP.(T_DRYPEAK)	45°C
START TIME	15:00
ADJUST	

12.2 FLOOR DRYING UP	
START DATE	01-01-2019
ENTER	EXIT
ADJUST	

During floor drying, all the buttons except OK are invalid. When the heat pump malfunctions, the floor drying mode will turn off when the backup heater and additional heating source is unavailable. If you want to turn off floor drying up, please press OK. The following page will be displayed:

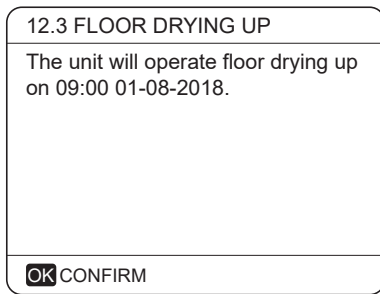

Use ◀ ▶ to scroll the cursor to YES and press OK. Floor drying will turn off.

The target outlet water temperature during floor drying up described in the picture below:

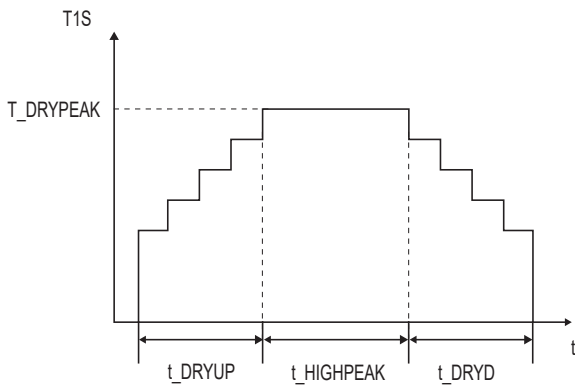

9.5.13 AUTO RESTART

The AUTO RESTART function is used to select whether the unit reapplies the user interface settings at the time when power returns after a power supply failure.

Go to MENU> FOR SERVICEMAN>13.AUTO RESTART

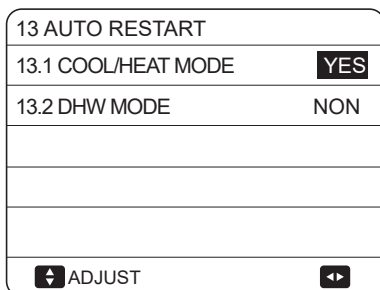

The AUTO RESTART function reapplies the user interface settings at the time of the power supply failure. If this function is disabled, when power returns after a power supply failure, the unit won't auto restart.

9.5.14 POWER INPUT LIMITATION

How to set the POWER INPUT LIMITATION

Go to MENU> FOR SERVICEMAN> 14.POWER INPUT LIMITATION

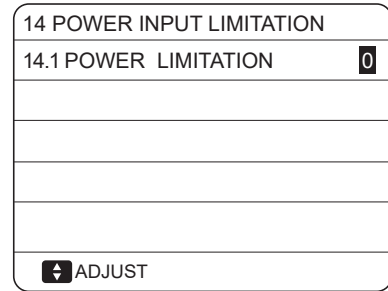

9.5.15 INPUT DEFINE

How to set the INPUT DEFINE

Go to MENU> FOR SERVICEMAN> 15.INPUT DEFINE

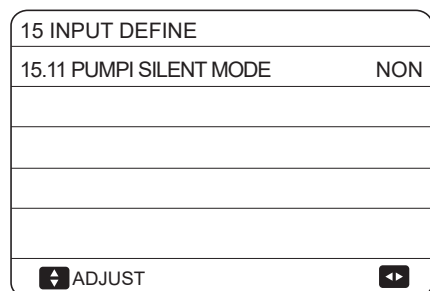
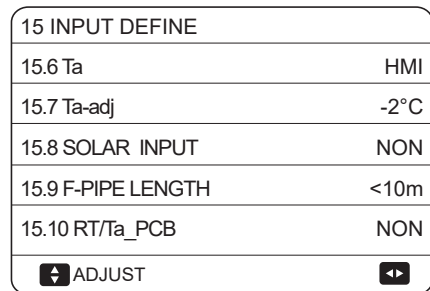
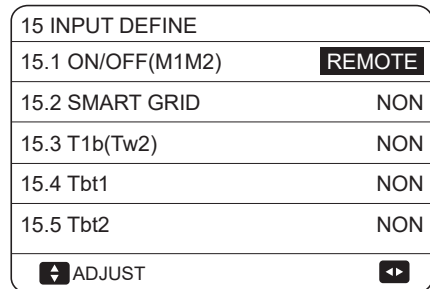

9.5.16 Setting parameters

The parameters related to this chapter are shown in the table below.

Order number	Code	State	Default	Minumum	Maximum	Setting interval	Unit
1.1	DHW MODE	Enable or disable the DHW mode:0=NON,1=YES	1	0	1	1	/
1.2	DISINFECT	Enable or disable the disinfect mode:0=NON,1=YES	1	0	1	1	/
1.3	DHW PRIORITY	Enable or disable the DHW priority mode:0=NON,1=YES	1	0	1	1	/
1.4	DHW PUMP	Enable or disable the DHW pump mode:0=NON,1=YES	0	0	1	1	/
1.5	DHW PRIORITY TIME SET	Enable or disable the DHW priority time set:0=NON,1=YES	0	0	1	1	/
1.6	dT5_ON	The temperature difference for starting the heat pump	10	1	30	1	°C
1.7	dT1S5	The difference value between Twout and T5 in DHW mode	10	5	40	1	°C
1.8	T4DHWMAX	The maximum ambient temperature that the heat pump can operate at for domestic water heating	43	35	43	1	°C
1.9	T4DHWMIN	The minimum ambient temperature that the heat pump can operate for domestic water heating	-10	-25	30	1	°C
1.10	t_INTERVAL_DHW	the start time interval of the compressor in DHW mode.	5	5	5	1	MIN
1.11	dT5_TBH_OFF	the temperature difference between T5 and T5S that turns the booster heater off.	5	0	10	1	°C
1.12	T4_TBH_ON	the highest outdoor temperature the TBH can operate.	5	-5	50	1	°C
1.13	t_TBH_DELAY	the time that the compressor has run before starting the booster heater	30	0	240	5	MIN
1.14	T5S_DI	the target temperature of water in the domestic hot water tank in the DISINFECT function.	65	60	70	1	°C
1.15	t_DI_HIGHTEMP.	the time that the highest temperature of water in the domestic hot water tank in the DISINFECT function will last	15	5	60	5	MIN
1.16	t_DI_MAX	the maximum time that disinfection will last	210	90	300	5	MIN
1.17	t_DHWHP_RESTRICT	he operation time for the space heating/cooling operation.	30	10	600	5	MIN
1.18	t_DHWHP_MAX	the maximum continuous working period of the heat pump in DHW PRIORITY mode.	90	10	600	5	MIN
1.19	DHW PUMP TIME RUN	Enable or disable the DHW pump run as timed and keeps running for PUMP RUNNING TIME:0=NON,1=YES	1	0	1	1	/
1.20	PUMP RUNNING TIME	the certain time that the DHW pump will keep running for	5	5	120	1	MIN
1.21	DHW PUMP DISINFECT	Enable or disable the DHW pump operate when the unit is in disinfect mode and $T5 \geq T5S_DI-2$:0=NON,1=YES	1	0	1	1	/
2.1	COOL MODE	Enable or disable the cooling mode:0=NON,1=YES	1	0	1	1	/
2.2	t_T4_FRESH_C	The refresh time of climate related curves for cooling mode	0.5	0.5	6	0.5	hours
2.3	T4CMAX	The highest ambient operation temperature for cooling mode	52	35	52	1	°C
2.4	T4CMIN	the lowest ambient operating temperature for cooling mode	10	-5	25	1	°C
2.5	dT1SC	the temperature difference for starting the heat pump(T1)	5	2	10	1	°C
2.6	dTSC	the temperature difference for starting the heat pump(Ta)	2	1	10	1	°C
2.7	t_INTERVAL_COOL	the start time interval of the compressor in COOL mode.	5	5	5	1	MIN
2.8	T1SetC1	The setting temperature 1 of climate related curves for cooling mode.	10	5	25	1	°C
2.9	T1SetC2	The setting temperature 2 of climate related curves for cooling mode.	16	5	25	1	°C
2.10	T4C1	The ambient temperature 1 of climate related curves for cooling mode.	35	-5	46	1	°C
2.11	T4C2	The ambient temperature 2 of climate related curves for cooling mode.	25	-5	46	1	°C
2.12	ZONE1 C-EMISSION	The type of zone1 end for cooling mode 0=FCU(fan coil unit), 1=RAD.(radiator), 2=FLH(floor heating)	0	0	2	1	/
2.13	ZONE2 C-EMISSION	The type of zone2 end for cooling mode 0=FCU(fan coil unit), 1=RAD.(radiator), 2=FLH(floor heating)	0	0	2	1	/

3.1	HEAT MODE	Enable or disable the heating mode	1	0	1	1	/
3.2	t_T4_FRESH_H	The refresh time of climate related curves for heating mode	0.5	0.5	6	0.5	hours
3.3	T4HMAX	The maximum ambient operating temperature for heating mode	25	20	35	1	°C
3.4	T4HMIN	The minimum ambient operating temperature for heating mode	-15	-25	30	1	°C
3.5	dT1SH	The temperature difference for starting the unit (T1)	5	2	20	1	°C
3.6	dTSH	The temperature difference for starting the unit (Ta)	2	1	10		°C
3.7	t_INTERVAL_HEAT	the start time interval of the compressor in HEAT mode.	5	5	5	1	MIN
3.8	T1SetH1	The setting temperature 1 of climate related curves for heating mode	35	25	65	1	°C
3.9	T1SetH2	The setting temperature 2 of climate related curves for heating mode	28	25	65	1	°C
3.10	T4H1	The ambient temperature 1 of climate related curves for heating mode	-5	-25	35	1	°C
3.11	T4H2	The ambient temperature 2 of climate related curves for heating mode	7	-25	35	1	°C
3.12	ZONE1 H-EMISSION	The type of zone1 end for heating mode : 0=FCU(fan coil unit), 1=RAD.(radiator), 2=FLH(floor heating)	1	0	2	1	/
3.13	ZONE2 H-EMISSION	The type of zone2 end for heating mode : 0=FCU(fan coil unit), 1=RAD.(radiator), 2=FLH(floor heating)	2	0	2	1	/
3.14	t_DELAY_PUMP	the time that the compressor has run before starting the pump.	2	0.5	20	0.5	MIN
4.1	T4AUTOCMIN	The minimum operating ambient temperature for cooling in auto mode	25	20	29	1	°C
4.2	T4AUTOHMAX	The maximum operating ambient temperature for heating in auto mode	17	10	17	1	°C
5.1	WATER FLOW TEMP.	Enable or disable the WATER FLOW TEMP.:0=NON,1=YES	1	0	1	1	/
5.2	ROOM TEMP.	Enable or disable the ROOM TEMP.:0=NON,1=YES	0	0	1	1	/
5.3	DOUBLE ZONE	Enable or disable the ROOM THERMOSTAT DOUBLE ZONE:0=NON,1=YES	0	0	1	1	/
6.1	ROOM THERMOSTAT	The style of room thermostat 0=NON,1=MODE SET,2=ONE ZONE,3=DOUBLE ZONE	0	0	3	1	/
7.1	dT1_IBH_ON	The temperature difference between T1S and T1 for starting the backup heater.	5	2	10	1	°C
7.2	t_IBH_DELAY	The time that the compressor has run before the first backup heater turns on	30	15	120	5	MIN
7.3	T4_IBH_ON	The ambient temperature for starting the backup heater	-5	-15	30	1	°C
7.4	dT1_AHS_ON	The temperature difference between T1S and T1B for turning the additional heating source on	5	2	20	1	°C
7.5	t_AHS_DELAY	The time that the compressor has run before starting the additional heating source	30	5	120	5	MIN
7.6	T4_AHS_ON	The ambient temperature for starting the additional heating source	-5	-15	30	1	°C
7.7	IBH_LOCATE	IBH/AHS installation location PIPE LOOP=0; BUFFER TANK=1	0	0	0	0	°C
7.8	P_IBH1	Power input of IBH1	0	0	20	0.5	kW
7.9	P_IBH2	Power input of IBH2	0	0	20	0.5	kW
7.10	P_TBH	Power input of TBH	2	0	20	0.5	kW
8.1	T1S_HA_H	The target outlet water temperature for space heating when in holiday away mode	25	20	25	1	°C
8.2	T5S_HA_DHW	The target outlet water temperature for domestic hot water heating when in holiday away mode	25	20	25	1	°C
12.1	PRE-HEATING FOR FLOOR T1S	The setting temperature of outlet water during first preheating for floor	25	25	35	1	°C
12.3	t_FIRSTFH	The time last for preheating floor	72	48	96	12	HOUR

12.4	t_DRYUP	The day for warming up during floor drying up	8	4	15	1	DAY
12.5	t_HIGHPEAK	The continue days in high temperature during floor drying up	5	3	7	1	DAY
12.6	t_DRYD	The day of dropping temperature during floor drying up	5	4	15	1	DAY
12.7	T_DRYPEAK	The target peak temperature of water flow during floor drying up	45	30	55	1	°C
12.8	START TIME	The start time of floor drying up	Hour: the present time(not on the hour +1, on the hour +2) Minute:00	0:00	23:30	1/30	h/min
12.9	START DATE	The start date of floor drying up	The present date	1/1/2000	31/12/2099	1/1/2001	d/m/y
13.1	AUTO RESTART COOL/HEAT MODE	Enable or disable the auto restart cooling/heating mode. 0=NON,1=YES	1	0	1	1	/
13.2	AUTO RESTART DHW MODE	Enable or disable the auto restart DHW mode. 0=NON,1=YES	1	0	1	1	/
14.1	POWER INPUT LIMITATION	The type of power input limitation, 0=NON, 1~8=TYPE 1~8	0	0	8	1	/
15.1	ON/OFF (M1 M2)	Define the function of the M1M2 switch; 0= REMOTE ON/OFF, 1= TBH ON/OFF, 2= AHS ON/OFF	0	0	2	1	/
15.2	SMART GRID	Enable or disable the SMART GRID; 0=NON,1=YES	0	0	1	1	/
15.3	T1b (Tw2)	Enable or disable the T1b(Tw2); 0=NON,1=YES	0	0	1	1	/
15.4	Tbt1	Enable or disable the Tbt1; 0=NON,1=YES	0	0	1	1	/
15.5	Tbt2	Enable or disable the Tbt2; 0=NON,1=YES	0	0	1	1	/
15.6	Ta	Enable or disable the Ta; 0=NON,1=YES	0	0	1	1	/
15.7	Ta-adj	The corrected value of Ta on wired controller	-2	-10	10	1	°C
15.8	SOLAR INPUT	Choose the SOLAR INPUT; 0=NON,1=CN18Tsolar,2=CN11SL1SL2	0	0	2	1	/
15.9	F-PIPE LENGTH	Choose the total length of the liquid pipe(F-PIPE LENGTH); 0=F-PIPE LENGTH<10m,1=F-PIPE LENGTH≥10m	0	0	1	1	/
15.10	RT/Ta_PCB	Enable or disable the RT/Ta_PCB; 0=NON,1=YES	0	0	1	1	/
15.11	PUMPI SILENT MODE	Enable or disable PUMPI SILENT MODE 0=NON, 1=YES	0	0	1	1	/
16.1	PER_START	Start-up percentage of multiple units	10	10	100	10	%
16.2	TIME_ADJUST	Adjustment time of adding and subtracting units	5	1	60	1	MIN
16.3	ADDRESS RESET	Reset the address code of the unit	FF	0	15	1	/
17.1	HMI SET	Choose the HMI; 0=MASTER,1=SLAVE	0	0	1	1	/
17.2	HMI ADDRESS FOR BMS	Set the HMI address code for BMS	1	1	16	1	/

10 TEST RUN AND FINAL CHECKS

The installer is obliged to verify correct operation of unit after installation.

10.1 Final checks

Before switching on the unit, read following recommendations:

- When the complete installation and all necessary settings have been carried out, close all front panels of the unit and refit the unit cover.
- The service panel of the switch box may only be opened by a licensed electrician for maintenance purposes.

NOTE

That during the first running period of the unit, required power input may be higher than stated on the nameplate of the unit. This phenomenon originates from the compressor that needs elapse of a 50 hours run in period before reaching smooth operation and stable power consumption.

10.2 Test run operation (manually)

If required, the installer can perform a manual test run operation at any time to check correct operation of air purge, heating, cooling and domestic water heating, refer to **9.5.11 "Test run"**.

11 MAINTENANCE AND SERVICE

In order to ensure optimal availability of the unit, a number of checks and inspections on the unit and the field wiring have to be carried out at regular intervals.

This maintenance needs to be carried out by your local technician.

In order to ensure optimal availability of the unit, a number of checks and inspections on the unit and the field wiring have to be carried out at regular intervals.

This maintenance has to be carried out by your local technician.

DANGER

ELECTRIC SHOCK

- Before carrying out any maintenance or repairing activity, must switch off the power supply on the supply panel.
- Do not touch any live part for 10 minutes after the power supply is turned off.
- The crank heater of compressor may operate even in standby.
- Please note that some sections of the electric component box are hot.
- Forbid touch any conductive parts.
- Forbid rinse the unit. It may cause electric shock or fire.

Forbid leave the unit unattended when service panel is removed.

The following checks must be performed at least once a year by qualified person.

- Water pressure
Check the water pressure, if it is below 1 bar, fill water to the system.
- Water filter
Clean the water filter.
- Water pressure relief valve
Check for correct operation of the pressure relief valve by turning the black knob on the valve counter-clockwise:
-If you do not hear a clacking sound, contact your local dealer.
-In case the water keeps running out of the unit, close both the water inlet and outlet shut-off valves first and then contact your local dealer.
- Pressure relief valve hose
Check that the pressure relief valve hose is positioned appropriately to drain the water.
- Backup heater vessel insulation cover
Check that the backup heater insulation cover is fastened tightly around the backup heater vessel.
- Domestic hot water tank pressure relief valve (field supply) Applies only to installations with a domestic hot water tank. Check for correct operation of the pressure relief valve on the domestic hot water tank.
- Domestic hot water tank booster heater
Applies only to installations with a domestic hot water tank. It is advisable to remove lime buildup on the booster heater to extend its life span, especially in regions with hard water. To do so, drain the domestic hot water tank, remove the booster heater from the domestic hot water tank and immerse in a bucket (or similar) with lime-removing product for 24 hours.
- Unit switch box
-Carry out a thorough visual inspection of the switch box and look for obvious defects such as loose connections or defective wiring.
-Check for correct operation of contactors with an ohm meter. All contacts of these contactors must be in open position.
Use of glycol (Refer to **8.5.4 "Water circuit anti-freeze protection"**) Document the glycol concentration and the pH-value in the system at least once a year.
-A PH-value below 8.0 indicates that a significant portion of the inhibitor has been depleted and that more inhibitor needs to be added.
-When the PH-value is below 7.0 then oxidation of the glycol occurred, the system should be drained and flushed thoroughly before severe damage occurs.

Make sure that the disposal of the glycol solution is done in accordance with relevant local laws and regulations.

12 TROUBLE SHOOTING

This section provides useful information for diagnosing and correcting certain troubles which may occur in the unit.

This troubleshooting and related corrective actions may only be carried out by your local technician.

12.1 General guidelines

Before starting the troubleshooting procedure, carry out a thorough visual inspection of the unit and look for obvious defects such as loose connections or defective wiring.

WARNING

When carrying out an inspection on the switch box of the unit, always make sure that the main switch of the unit is switched off.

When a safety device was activated, stop the unit and find out why the safety device was activated before resetting it. Under no circumstances can safety devices be bridged or changed to a value other than the factory setting. If the cause of the problem cannot be found, call your local dealer.

If the pressure relief valve is not working correctly and is to be replaced, always reconnect the flexible hose attached to the pressure relief valve to avoid water dripping out of the unit!

NOTE

For problems related to the optional solar kit for domestic water heating, refer to the troubleshooting in the Installation and owner's manual for that kit.

12.2 General symptoms

Symptom 1: The unit is turned on but the unit is not heating or cooling as expected

POSSIBLE CAUSES	CORRECTIVE ACTION
The temperature setting is not correct.	Check the parameters.T4HMAX,T4HMIN in heat mode. T4CMAX,T4CMIN in cool mode.T4DHWMAX,T4DHWMIN in DHW mode.
The water flow is too low.	<ul style="list-style-type: none"> • Check that all shut off valves of the water circuit are in the right position. • Check if the water filter is plugged. • Make sure there is no air in the water system. • Check on the manometer that there is sufficient water pressure. The water pressure must be >1 bar (water is cold). • Make sure that the expansion vessel is not broken. • Check that the resistance in the water circuit is not too high for the pump.
The water volume in the installation is too low.	Make sure that the water volume in the installation is above the minimum required value (refer to " 8.5.2 Water volume and sizing expansion vessels ").

Symptom 2: The unit is turned on but the compressor is not starting (space heating or domestic water heating)

POSSIBLE CAUSES	CORRECTIVE ACTION
The unit maybe operate out of its operation range (the water temperature is too low).	<p>In case of low water temperature, the system utilizes the backup heater to reach the minimum water temperature first (12°C).</p> <ul style="list-style-type: none"> • Check that the backup heater power supply is correct. • Check that the backup heater thermal fuse is closed. • Check that the backup heater thermal protector is not activated. • Check that the backup heater contactors are not broken.

Symptom 3: Pump is making noise (cavitation)

POSSIBLE CAUSES	CORRECTIVE ACTION
There is air in the system.	Purge air.
Water pressure at pump inlet is too low.	<ul style="list-style-type: none"> • Check on the manometer that there is sufficient water pressure. The water pressure must be > 1 bar (water is cold). • Check that the manometer is not broken. • Check that the expansion vessel is not broken. • Check that the setting of the pre- pressure of the expansion vessel is correct (refer to "8.5.2 Water volume and sizing expansion vessels").

Symptom 4: The water pressure relief valve opens

POSSIBLE CAUSES	CORRECTIVE ACTION
The expansion vessel is broken.	Replace the expansion vessel.
The filling water pressure in the installation is higher than 0.3MPa.	Make sure that the filling water pressure in the installation is about 0.10~0.20MPa (refer to " 8.5.2 Water volume and sizing expansion vessels ").

Symptom 5: The water pressure relief valve leaks

POSSIBLE CAUSES	CORRECTIVE ACTION
Dirt is blocking the water pressure relief valve outlet.	<p>Check for correct operation of the pressure relief valve by turning the red knob on the valve counter clockwise:</p> <ul style="list-style-type: none"> • If you do not hear a clacking sound, contact your local dealer. • In case the water keeps running out of the unit, close both the water inlet and outlet shut-off valves first and then contact your local dealer.

Symptom 6: Space heating capacity shortage at low outdoor temperatures

POSSIBLE CAUSES	CORRECTIVE ACTION
Backup heater operation is not activated.	<p>Check that the "OTHER HEATING SOURCE/ BACKUP HEATER" is enabled, see "9.5 Field settings". Check whether or not the thermal protector of the backup heater has been activated (refer to "Controls parts for backup heater (IBH)"). Check if booster heater is running, the backup heater and booster heater can't operate simultaneously.</p>
Too much heat pump capacity is used for heating domestic hot water (applies only to installations with a domestic hot water tank).	<p>Check that the "t_DHWHP_MAX" and "t_DHWHP_RESTRICT" are configured appropriately:</p> <ul style="list-style-type: none"> • Make sure that the "DHW PRIORITY" in the user interface is disabled. • Enable the "T4_TBH_ON" in the user interface/FOR SERVICEMAN to activate the booster heater for domestic water heating.

Symptom 7: Heat mode can't change to DHW mode immediately

POSSIBLE CAUSES	CORRECTIVE ACTION
Volume of tank is too small and the location of water temperature probe not high enough	<ul style="list-style-type: none"> • Set "dT1S5" to maximum value, and set "t_DHWHP_RESTRICT" to minimum value. • Set dT1SH to 2°C. • Enable TBH, and TBH should be controlled by the outdoor unit. • If AHS is available, turn on first, if requirement for turn heat pump on is fulfilled, the heat pump will turn on. • If both TBH and AHS are not available, try to change the position of T5 probe (refer to 5 "General introduction").

Symptom 8: DHW mode can't change to Heat mode immediately

POSSIBLE CAUSES	CORRECTIVE ACTION
Heat exchanger for space heating not big enough	<ul style="list-style-type: none"> Set "t_DHWHP_MAX" to minimum value, the suggested value is 60min. If circulating pump out of unit is not controlled by unit, try to connect it to the unit. Add 3-way valve at the inlet of fan coil to ensure enough water flow.
Space heating load is small	Normal , no need for heating
Disinfect function is enabled but without TBH	<ul style="list-style-type: none"> Disable disinfect function add TBH or AHS for DHW mode
Manual turn on the FAST WATER function, after the hot water meets the requirements, the heat pump fails to switch to the air-conditioning mode in time when the air conditioner is in demand	Manual turn off the FAST WATER function
When the ambient temperature is low, the hot water is not enough and the AHS is not operated or operated late	<ul style="list-style-type: none"> Set "T4DHWMIN", the suggested value is $\geq -5^{\circ}\text{C}$ Set "T4_TBH_ON", the suggested value is $\geq 5^{\circ}\text{C}$
DHW mode priority	If there is AHS or IBH connect to the unit, when the outdoor unit failed, the indoor unit must run DHW mode till the water temperature reach the setting temperature before change to heating mode.

Symptom 9: DHW mode heat pump stop work but setpoint not reached, space heating require heat but unit stay in DHW mode

POSSIBLE CAUSES	CORRECTIVE ACTION
Surface of coil in the tank not large enough	The same solution for Symptom 7
TBH or AHS not available	Heat pump will stay in DHW mode until "t_DHWHP_MAX" reached or setpoint is reached. Add TBH or AHS for DHW mode, TBH and AHS should be controlled by the unit.

12.3 Operation parameter

This menu is for installer or service engineer reviewing the operation parameters.

- At home page, go to "MENU">"OPERATION PARAMETER".
- Press "OK". There are nine pages for the operating parameter as following. Press "▼", "▲" to scroll.

OPERATION PARAMETER	#00
ONLINE UNITS NUMBER	1
OPERATE MODE	COOL
SV1 STATE	ON
SV2 STATE	OFF
SV3 STATE	OFF
PUMP_I	ON
ADDRESS	1/9

OPERATION PARAMETER	#00
PUMP-O	OFF
PUMP-C	OFF
PUMP-S	OFF
PUMP-D	OFF
PIPE BACKUP HEATER	OFF
TANK BACKUP HEATER	ON
ADDRESS	2/9

OPERATION PARAMETER	#00
GAS BOILER	OFF
T1 LEAVING WATER TEMP.	35°C
WATER FLOW	1.72m ³ /h
HEAT PUMP CAPACTIY	11.52kW
POWER CONSUM.	1000kWh
Ta ROOM TEMP	25°C
ADDRESS	3/9

OPERATION PARAMETER	#00
T5 WATER TANK TEMP.	53°C
Tw2 CIRCUIT2 WATER TEMP.	35°C
TIS' C1 CLI. CURVE TEMP.	35°C
TIS2' C2 CLI. CURVE TEMP.	35°C
TW_O PLATE W-OUTLET TEMP.	35°C
TW_I PLATE W-INLET TEMP.	30°C
ADDRESS	4/9

OPERATION PARAMETER	#00
Tbt1 BUFFERTANK_UP TEMP.	35°C
Tbt2 BUFFERTANK_LOW TEMP.	35°C
Tsolar	25°C
IDU SOFTWARE	01-09-2019V01
ADDRESS	5/9

OPERATION PARAMETER	#00
ODU MODEL	6kW
COMP.CURRENT	12A
COMP.FREQUENCY	24Hz
COMP.RUN TIME	54 MIN
COMP.TOTAL RUN TIME	1000Hrs
EXPANSION VALVE	200P
ADDRESS	6/9

OPERATION PARAMETER	#00
FAN SPEED	600R/MIN
IDU TARGET FREQUENCY	46Hz
FREQUENCY LIMITED TYPE	5
SUPPLY VOLTAGE	230V
DC GENERATRIX VOLTAGE	420V
DC GENERATRIX CURRENT	18A
ADDRESS	7/9

OPERATION PARAMETER	#00
TW_O PLATE W-OUTLET TEMP.	35°C
TW_I PLATE W-INLET TEMP.	30°C
T2 PLATE F-OUT TEMP.	35°C
T2B PLATE F-IN TEMP.	35°C
Th COMP. SUCTION TEMP.	5°C
Tp COMP. DISCHARGE TEMP.	75°C
ADDRESS	8/9

OPERATION PARAMETER	#00
T3 OUTDOOR EXCHANGE TEMP.	5°C
T4 OUTDOOR AIR TEMP.	5°C
TF MODULE TEMP.	55°C
P1 COMP. PRESSURE	2300kPa
ODU SOFTWARE	01-09-2018V01
HMI SOFTWARE	01-09-2018V01
ADDRESS	9/9

NOTE

The power consumption parameter is preparatory. some parameter is not be activated in the system, the parameter will show "--"

The heat pump capacity is for reference only, not used to judge the ability of the unit. The accuracy of sensor is $\pm 1^{\circ}\text{C}$. The flow rates parameters are calculated according to the pump running parameters, the deviation is different at different flow rates, the maximum of deviation is 25%.

12.4 Error codes

When a safety device is activated, an error code will be displayed on the user interface.

A list of all errors and corrective actions can be found in the table below.

Reset the safety by turning the unit OFF and back ON.

In case this procedure for resetting the safety is not successful, contact your local dealer.

ERROR CODE	MALFUNCTION OR PROTECTION	FAILURE CAUSE AND CORRECTIVE ACTION
<i>E0</i>	Water flow fault(after 3 times E8)	<ol style="list-style-type: none"> 1.The wire circuit is short connected or open. Reconnect the wire correctly. 2.Water flow rate is too low. 3. Water flow switch is failed, switch is open or close continuously, change the water flow switch.
<i>E2</i>	Communication fault between controller and indoor unit	<ol style="list-style-type: none"> 1.Wire doesn't connect between wired controller and unit. connect the wire. 2.Communication wire sequence is not right. Reconnect the wire in the right sequence. 3.Whether there is a high magnetic field or high power interfere, such as lifts, large power transformers, etc.. <p>To add a barrier to protect the unit or to move the unit to the other place.</p>
<i>E3</i>	Final outlet water temp.sensor(T1) fault	<ol style="list-style-type: none"> 1.Check the resistance of the sensor 2.The T1 sensor connector is loosen. Reconnect it. 3.The T1 sensor connector is wet or there is water in. remove the water, make the connector dry. Add waterproof adhesive. 4.The T1 sensor failure, change a new sensor.
<i>E4</i>	water tank temp.sensor (T5) fault	<ol style="list-style-type: none"> 1.Check the resistance of the sensor 2.The T5 sensor connector is loosen. Reconnect it. 3.The T5 sensor connector is wet or there is water in. remove the water, make the connector dry. Add waterproof adhesive 4.The T5 sensor failure, change a new sensor. 5.If you want to close the domestic water heating when T5 sensor do not connected to the system, then T5 sensor can not be detected, refer to 9.5.1 "DHW MODE SETTING"
<i>E8</i>	Water flow failure	<p>Check that all shut off valves of the water circuit are completely open.</p> <ol style="list-style-type: none"> 1. Check if the water filter needs cleaning. 2. Refer to "8.6 Filling water" 3. Make sure there is no air in the system(purge air). 4. Check on the manometer that there is sufficient water pressure. The water pressure must be >1 bar. 5. Check that the pump speed setting is on the highest speed. 6. Make sure that the expansion vessel is not broken. 7. Check that the resistance in the water circuit is not too high for the pump (refer to "9.4 Setting the pump"). 8. If this error occurs at defrost operation (during space heating or domestic water heating), make sure that the backup heater power supply is wired correctly and that fuses are not blown. 9. Check that the pump fuse and PCB fuse are not blown.
<i>Ed</i>	Inlet water temp.sensor (Tw_in) malfunction	<ol style="list-style-type: none"> 1.Check the resistance of the sensor 2. The Tw_in sensor connector is loosen. Re connect it. 3.The Tw_in sensor connector is wet or there is water in. remove the water, make the connector dry. Add waterproof adhesive 4. The Tw_in sensor failure, change a new sensor.

ERROR CODE	MALFUNCTION OR PROTECTION	FAILURE CAUSE AND CORRECTIVE ACTION
<i>EE</i>	Indoor unit EEPROM failure	<ol style="list-style-type: none"> 1. The EEPROM parameter is error, rewrite the EEPROM data. 2. EEPROM chip part is broken, change a new EEPROM chip part. 3. main control board of indoor unit is broken, change a new PCB.
<i>H0</i>	Communication fault between indoor unit and outdoor unit	<ol style="list-style-type: none"> 1. wire doesn't connect between outdoor unit and main control board of indoor unit. connect the wire. 2. Communication wire sequence is not right. Reconnect the wire in the right sequence. 3. Whether there is a high magnetic field or high power interfere, such as lifts, large power transformers, etc.. To add a barrier to protect the unit or to move the unit to the other place.
<i>H2</i>	Refrigerant liquid temp.sensor(T2) fault	<ol style="list-style-type: none"> 1. Check the resistance of the sensor 2. The T2 sensor connector is loosen. Re connect it. 3. The T2 sensor connector is wet or there is water in. remove the water, make the connector dry. Add waterproof adhesive 4. The T2 sensor failure, change a new sensor.
<i>H3</i>	Refrigerant gas temp.sensor(T2B) fault	<ol style="list-style-type: none"> 1. Check the resistance of the sensor 2. The T2B sensor connector is loosen. Reconnect it. 3. The T2B sensor connector is wet or there is water in. remove the water, make the connector dry. Add waterproof adhesive 4. The T2B sensor failure, change a new sensor.
<i>H5</i>	Room temp.sensor(Ta) fault	<ol style="list-style-type: none"> 1. Check the resistance of the sensor 2. The Ta sensor is in the interface; 3. The Ta sensor failure, change a new sensor or change a new interface, or reset the Ta, connect a new Ta from the indoor unit PCB
<i>H9</i>	Outlet water for zone 2 temp.sensor (Tw2) fault	<ol style="list-style-type: none"> 1. Check the resistance of the sensor 2. The T1B sensor connector is loosen. Reconnect it. 3. The T1B sensor connector is wet or there is water in. Remove the water, make the connector dry. add waterproof adhesive 4. The T1B sensor failure, change a new sensor.
<i>HR</i>	Outlet water temp.sensor(Tw_out) fault	<ol style="list-style-type: none"> 1. The TW_out sensor connector is loosen. Reconnect it. 2. The TW_out sensor connector is wet or there is water in. remove the water, make the connector dry. add waterproof adhesive 3. The TW_out sensor failure, change a new sensor.
<i>PS</i>	Tw_out - Tw_in value too big protection	<ol style="list-style-type: none"> 1. Check that all shut off valves of the water circuit are completely open. 2. Check if the water filter needs cleaning. 3. Refer to "8.6 Filling water" 4. Make sure there is no air in the system (purge air). 5. Check on the manometer that there is sufficient water pressure. The water pressure must be >1 bar(water is cold). 6. Check that the pump speed setting is on the highest speed. 7. Make sure that the expansion vessel is not broken. 8. Check that the resistance in the water circuit is not too high for the pump. (refer to "9.4 Setting the pump").
<i>Pb</i>	Anti-freeze mode	Unit will return to the normal operation automatically.
<i>PP</i>	Tw_out - Tw_in unusual protection	<ol style="list-style-type: none"> 1. Check the resistance of the two sensor 2. Check the two sensors locations 3. The water inlet/outlet sensor wire connector is loosen. Reconnect it. 4. The water inlet/outlet (TW_in /TW_out) sensor is broken, Change a new sensor. 5. Four-way valve is blocked. Restart the unit again to let the valve change the direction. 6. Four-way valve is broken, change a new valve.

ERROR CODE	MALFUNCTION OR PROTECTION	FAILURE CAUSE AND CORRECTIVE ACTION
<i>Hb</i>	Three times "PP" protection and Tw_out < 7°C	The same to "PP".
<i>E7</i>	Buffer tank up temp.sensor(Tbt1) fault	<ol style="list-style-type: none"> 1.Check the resistance of the sensor. 2.The Tbt1 sensor connector is loosen,reconnect it. 3.The Tbt1 sensor connector is wet or there is water in,remove the water ,make the connector dry.Add waterproof adhesive. 4.The Tbt1 sensor failure,change a new sensor."
<i>Eb</i>	Solar temp.sensor(Tsolar) fault	<ol style="list-style-type: none"> 1.Check the resistance of the sensor. 2.The Tsolar sensor connector is loosen,reconnect it. 3.The Tsolar sensor connector is wet or there is water in,remove the water ,make the connector dry.Add waterproof adhesive. 4.The Tsolar sensor failure,change a new sensor."
<i>Ec</i>	Buffer tank low temp.sensor(Tbt2) fault	<ol style="list-style-type: none"> 1.Check the resistance of the sensor. 2.The Tbt2 sensor connector is loosen,reconnect it. 3.The Tbt2 sensor connector is wet or there is water in,remove the water ,make the connector dry.Add waterproof adhesive. 4.The Tbt2 sensor failure,change a new sensor."
<i>HE</i>	Communication error between main board and thermostat transferboard	RT/Ta PCB is set to be valid on user interface but the thermostat transfer board is not connected or the communication between thermostat transfer board and main board is not effectively connected. If the thermostat transfer board is not needed , set the RT/Ta PCB to invalid. If the thermostat transfer board is needed , please connect it to the main board and make sure the communication wire is connected well and there is no strong electricity or strong magnetic interference.

 **CAUTION**

- In winter, if the unit has E0 and Hb failure and the unit is not repaired in time, the water pump and pipeline system may be damaged by freezing, so E0 and Hb failure must be repaired in time.

13 TECHNICAL SPECIFICATIONS

Indoor unit model	60	100	160
Power supply	220-240V~ 50Hz		
Rated input	95W	95W	95W
Rated Current	0.4A	0.4A	0.4A
Norminal capacity	Refer to the technical data		
Dimensions (W×H×D)[mm]	420x790x270		
Packing (W×H×D)[mm]	525x1050x360		
Heat exchanger	Plate heat exchanger		
Electric heater	/		
Internal water volume	5.0L		
Rated water pressure	0.3MPa		
Filter mesh	60		
Min. water flow (flow switch)	6L/min		10L/min
Pump			
Type	DC inverter		
Max. head	9m		
Power input	5~90W		
Expanssion vessel			
Volume	8L		
Max. operating pressure	0.3MPa(g)		
Pre-charge pressure	0.10MPa(g)		
Weight			
Net weight	37kg	37kg	39kg
Gross weight	43kg	43kg	45kg
Connections			
Refrigerant gas/liquid side	Φ15.9/Φ6.35	Φ15.9/Φ9.52	Φ15.9/Φ9.52
Water inlet/outlet	R1"		
Drain connection	Φ25		
Operation range			
Outlet water(heating model)	+12 ~ +65 °C		
Outlet water(cooling model)	+5 ~ +30 °C		
Domestic hot water	+12 ~ +60 °C		
Ambient temperature	+5 ~ +35 °C		
Water pressure	0.1 ~ 0.3MPa		

Indoor unit model	60 (3kW Heater)	100 (3kW Heater)	160 (3kW Heater)	60 (9kW Heater)	100 (9kW Heater)	160 (9kW Heater)
Power supply	220-240V~ 50Hz			380~415V 3N~ 50Hz		
Rated input	3095W	3095W	3095W	9095W	9095W	9095W
Rated Current	13.5A	13.5A	13.5A	13.3A	13.3A	13.3A
Norminal capacity	Refer to the technical data					
Dimensions (W×H×D)[mm]	420×790×270					
Packing (W×H×D)[mm]	525×1050×360					
Heat exchanger	Plate heat exchanger					
Electric heater	3000W	3000W	3000W	9000W	9000W	9000W
Internal water volume	5.0L					
Rated water pressure	0.3MPa					
Filter mesh	60					
Min. water flow (flow switch)	6L/min		10L/min	6L/min		10L/min
Pump						
Type	DC inverter					
Max. head	9m					
Power input	5~90W					
Expansion vessel						
Volume	8L					
Max. operating pressure	0.3MPa(g)					
Pre-charge pressure	0.10MPa(g)					
Weight						
Net weight	43kg	43kg	45kg	43kg	43kg	45kg
Gross weight	49kg	49kg	51kg	49kg	49kg	51kg
Connections						
Refrigerant gas/liquid side	Φ15.9/Φ6.35	Φ15.9/Φ9.52	Φ15.9/Φ9.52	Φ15.9/Φ6.35	Φ15.9/Φ9.52	Φ15.9/Φ9.52
Water inlet/outlet	R1"					
Drain connection	Φ25					
Operation range						
Outlet water(heating model)	+12~+65℃					
Outlet water(cooling model)	+5~+30℃					
Domestic hot water	+12~+60℃					
Ambient temperature	0~+35℃					
Water pressure	0.1~0.3MPa					

14 INFORMATION SERVICING

1) Checks to the area

Prior to beginning work on systems containing flammable refrigerants, safety checks are necessary to ensure that the risk of ignition is minimised. For repair to the refrigerating system, the following precautions shall be complied with prior to conducting work on the system.

2) Work procedure

Works shall be undertaken under a controlled procedure so as to minimise the risk of a flammable gas or vapour being present while the work is being performed.

3) General work area

All maintenance staff and others working in the local area shall be instructed on the nature of work being carried out, work in confined spaces shall be avoided. The area around the work space shall be sectioned off. Ensure that the conditions within the area have been made safe by control of flammable material.

4) Checking for presence of refrigerant

The area shall be checked with an appropriate refrigerant detector prior to and during work, to ensure the technician is aware of potentially flammable atmospheres. Ensure that the leak detection equipment being used is suitable for use with flammable refrigerants, i.e. no sparking, adequately sealed or intrinsically safe.

5) Presence of fire extinguisher

If any hot work is to be conducted on the refrigeration equipment or any associated parts, appropriate fire extinguishing equipment shall be available to hand. Have a dry power or CO₂ fire extinguisher adjacent to the charging area.

6) No ignition sources

No person carrying out work in relation to a refrigeration system which involves exposing any pipe work that contains or has contained flammable refrigerant shall use any sources of ignition in such a manner that it may lead to the risk of fire or explosion. All possible ignition sources, including cigarette smoking, should be kept sufficiently far away from the site of installation, repairing, removing and disposal, during which flammable refrigerant can possibly be released to the surrounding space. Prior to work taking place, the area around the equipment is to be surveyed to make sure that there are no flammable hazards or ignition risks. NO SMOKING signs shall be displayed.

7) Ventilated area

Ensure that the area is in the open or that it is adequately ventilated before breaking into the system or conducting any hot work. A degree of ventilation shall continue during the period that the work is carried out. The ventilation should safely disperse any released refrigerant and preferably expel it externally into the atmosphere.

8) Checks to the refrigeration equipment

Where electrical components are being changed, they shall be fit for the purpose and to the correct specification. At all times the manufacturer's maintenance and service guidelines shall be followed. If in doubt consult the manufacturer's technical department for assistance. The following checks shall be applied to installations using flammable refrigerants:

- The charge size is in accordance with the room size within which the refrigerant containing parts are installed;
- The ventilation machinery and outlets are operating adequately and are not obstructed;
- If an indirect refrigerating circuit is being used, the secondary circuits shall be checked for the presence of refrigerant; marking to the equipment continues to be visible and legible.
- Marking and signs that are illegible shall be corrected;
- Refrigeration pipe or components are installed in a position where they are unlikely to be exposed to any substance which may corrode refrigerant containing components, unless the components are constructed of materials which are inherently resistant to being corroded or are suitably protected against being so corroded.

9) Checks to electrical devices

Repair and maintenance to electrical components shall include initial safety checks and component inspection procedures. If a fault exists that could compromise safety, then no electrical supply shall be connected to the circuit until it is satisfactorily dealt with. If the fault cannot be corrected immediately but it is necessary to continue operation, an adequate temporary solution shall be used. This shall be reported to the owner of the equipment so all parties are advised.

Initial safety checks shall include:

- That capacitors are discharged: this shall be done in a safe manner to avoid possibility of sparking;
- That there are no live electrical components and wiring are exposed while charging, recovering or purging the system;
- That there is continuity of earth bonding.

10) Repairs to sealed components

a) During repairs to sealed components, all electrical supplies shall be disconnected from the equipment being worked upon prior to any removal of sealed covers, etc. If it is absolutely necessary to have an electrical supply to equipment during servicing, then a permanently operating form of leak detection shall be located at the most critical point to warn of a potentially hazardous situation.

b) Particular attention shall be paid to the following to ensure that by working on electrical components, the casing is not altered in such a way that the level of protection is affected. This shall include damage to cables, excessive number of connections, terminals not made to original specification, damage to seals, incorrect fitting of glands, etc.

- Ensure that apparatus is mounted securely.
- Ensure that seals or sealing materials have not degraded such that they no longer serve the purpose of preventing the ingress of flammable atmospheres. Replacement parts shall be in accordance with the manufacturer's specifications.

NOTE

The use of silicon sealant may inhibit the effectiveness of some types of leak detection equipment. Intrinsically safe components do not have to be isolated prior to working on them.

11) Repair to intrinsically safe components

Do not apply any permanent inductive or capacitance loads to the circuit without ensuring that this will not exceed the permissible voltage and current permitted for the equipment in use. Intrinsically safe components are the only types that can be worked on while live in the presence of a flammable atmosphere. The test apparatus shall be at the correct rating. Replace components only with parts specified by the manufacturer. Other parts may result in the ignition of refrigerant in the atmosphere from a leak.

12) Cabling

Check that cabling will not be subject to wear, corrosion, excessive pressure, vibration, sharp edges or any other adverse environmental effects. The check shall also take into account the effects of aging or continual vibration from sources such as compressors or fans.

13) Detection of flammable refrigerants

Under no circumstances shall potential sources of ignition be used in the searching for or detection of refrigerant leaks. A halide torch (or any other detector using a naked flame) shall not be used.

14) Leak detection methods

The following leak detection methods are deemed acceptable for systems containing flammable refrigerants. Electronic leak detectors shall be used to detect flammable refrigerants, but the sensitivity may not be adequate, or may need re-calibration. (Detection equipment shall be calibrated in a refrigerant-free area.) Ensure that the detector is not a potential source of ignition and is suitable for the refrigerant. Leak detection equipment shall be set at a percentage of the LFL of the refrigerant and shall be calibrated to the refrigerant employed and the appropriate percentage of gas (25% maximum) is confirmed. Leak detection fluids are suitable for use with most refrigerants but the use of detergents containing chlorine shall be avoided as the chlorine may react with the refrigerant and corrode the copper pipe-work. If a leak is suspected, all naked flames shall be removed or extinguished. If a leakage of refrigerant is found which requires brazing, all of the refrigerant shall be recovered from the system, or isolated (by means of shut off valves) in a part of the system remote from the leak. Oxygen free nitrogen (OFN) shall then be purged through the system both before and during the brazing process.

15) Removal and evacuation

When breaking into the refrigerant circuit to make repairs or for any other purpose conventional procedures shall be used. However, it is important that best practice is followed since flammability is a consideration. The following procedure shall be adhered to:

- Remove refrigerant;
- Purge the circuit with inert gas;
- Evacuate;
- Purge again with inert gas;
- Open the circuit by cutting or brazing.

The refrigerant charge shall be recovered into the correct recovery cylinders. The system shall be flushed with OFN to render the unit safe. This process may need to be repeated several times.

Compressed air or oxygen shall not be used for this task.

Flushing shall be achieved by breaking the vacuum in the system with OFN and continuing to fill until the working pressure is achieved, then venting to atmosphere, and finally pulling down to a vacuum. This process shall be repeated until no refrigerant is within the system.

When the final OFN charge is used, the system shall be vented down to atmospheric pressure to enable work to take place. This operation is absolutely vital if brazing operations on the pipe-work are to take place. Ensure that the outlet for the vacuum pump is not closed to any ignition sources and there is ventilation available.

16) Charging procedures

In addition to conventional charging procedures, the following requirements shall be followed:

- Ensure that contamination of different refrigerants does not occur when using charging equipment. Hoses or lines shall be as short as possible to minimize the amount of refrigerant contained in them.
- Cylinders shall be kept upright.
- Ensure that the refrigeration system is earthed prior to charging the system with refrigerant.
- Label the system when charging is complete(if not already).
- Extreme care shall be taken not to overfill the refrigeration system.
- Prior to recharging the system it shall be pressure tested with OFN. The system shall be leak tested on completion of charging but prior to commissioning. A follow up leak test shall be carried out prior to leaving the site.

17) Decommissioning

Before carrying out this procedure, it is essential that the technician is completely familiar with the equipment and all its detail. It is recommended good practice that all refrigerants are recovered safely. Prior to the task being carried out, an oil and refrigerant sample shall be taken.

In case analysis is required prior to re-use of reclaimed refrigerant. It is essential that electrical power is available before the task is commenced.

a) Become familiar with the equipment and its operation.

b) Isolate system electrically

c) Before attempting the procedure ensure that:

- Mechanical handling equipment is available, if required, for handling refrigerant cylinders;
- All personal protective equipment is available and being used correctly;
- The recovery process is supervised at all times by a competent person;
- Recovery equipment and cylinders conform to the appropriate standards.

d) Pump down refrigerant system, if possible.

e) If a vacuum is not possible, make a manifold so that refrigerant can be removed from various parts of the system.

f) Make sure that cylinder is situated on the scales before recovery takes place.

g) Start the recovery machine and operate in accordance with manufacturer's instructions.

h) Do not overfill cylinders. (No more than 80% volume liquid charge).

i) Do not exceed the maximum working pressure of the cylinder, even temporarily.

j) When the cylinders have been filled correctly and the process completed, make sure that the cylinders and the equipment are removed from site promptly and all isolation valves on the equipment are closed off.

k) Recovered refrigerant shall not be charged into another refrigeration system unless it has been cleaned and checked.

18) Labelling

Equipment shall be labelled stating that it has been de-commissioned and emptied of refrigerant. The label shall be dated and signed. Ensure that there are labels on the equipment stating the equipment contains flammable refrigerant.

19) Recovery

When removing refrigerant from a system, either for service or decommissioning, it is recommended good practice that all refrigerants are removed safely.

When transferring refrigerant into cylinders, ensure that only appropriate refrigerant recovery cylinders are employed. Ensure that the correct numbers of cylinders for holding the total system charge are available. All cylinders to be used are designated for the recovered refrigerant and labelled for that refrigerant (i.e special cylinders for the recovery of refrigerant). Cylinders shall be complete with pressure relief valve and associated shut-off valves in good working order.

Empty recovery cylinders are evacuated and, if possible, cooled before recovery occurs.

The recovery equipment shall be in good working order with a set of instructions concerning the equipment that is at hand and shall be suitable for the recovery of flammable refrigerants. In addition, a set of calibrated weighing scales shall be available and in good working order.

Hoses shall be complete with leak-free disconnect couplings and in good condition. Before using the recovery machine, check that it is in satisfactory working order, has been properly maintained and that any associated electrical components are sealed to prevent ignition in the event of a refrigerant release. Consult manufacturer if in doubt.

The recovered refrigerant shall be returned to the refrigerant supplier in the correct recovery cylinder, and the relevant Waste Transfer Note arranged. Do not mix refrigerants in recovery units and especially not in cylinders.

If compressors or compressor oils are to be removed, ensure that they have been evacuated to an acceptable level to make certain that flammable refrigerant does not remain within the lubricant. The evacuation process shall be carried out prior to re-truning the compressor to the suppliers. Only electric heating to the compressor body shall be employed to accelerate this process. When oil is drained from a system, it shall be carried out safely.

20) Transportation, marking and storage for units

Transport of equipment containing flammable refrigerants Compliance with the transport regulations

Marking of equipment using signs Compliance with local regulations

Disposal of equipment using flammable refrigerants Compliance with national regulations

Storage of equipment/appliances

The storage of equipment should be in accordance with the manufacturer's instructions.

Storage of packed (unsold) equipment

Storage package protection should be constructed such that mechanical damage to the equipment inside the package will not cause a leak of the refrigerant charge.

The maximum number of pieces of equipment permitted to be stored together will be determined by local regulations.

ANNEX A: Refrigerant cycle

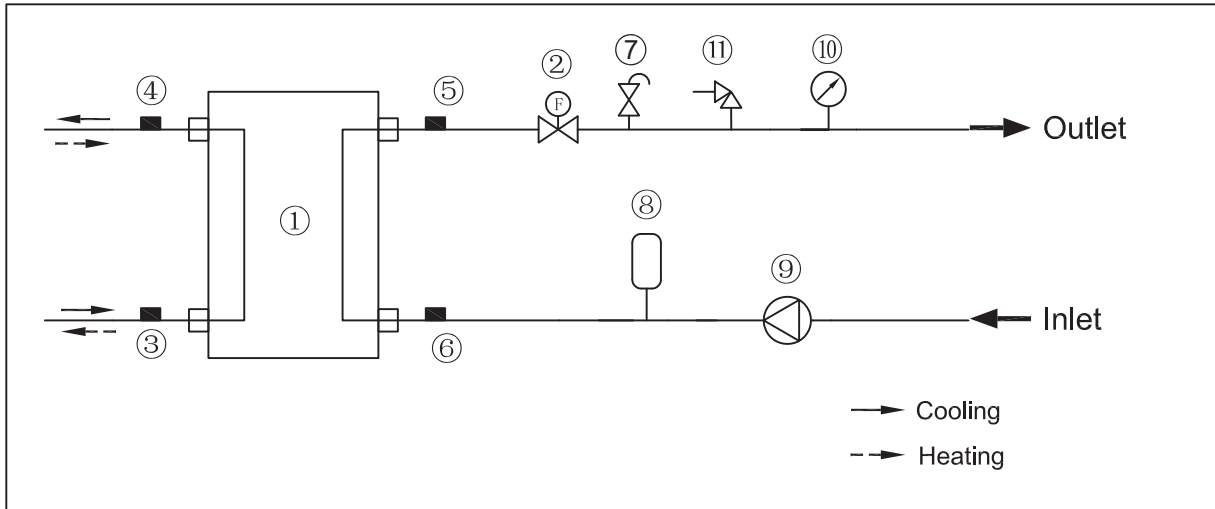

Basic

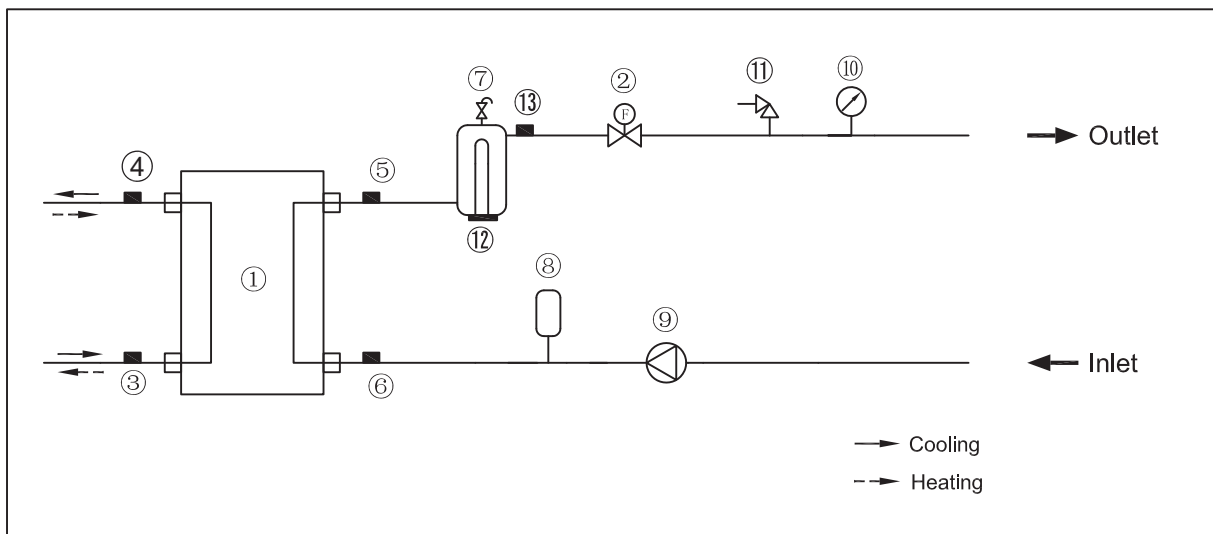

Customized

Item	Description	Item	Description
1	Water Side Heat Exchanger (Plate Heat Exchange)	8	Expansion vessel
2	Flow switch	9	Circulating pump
3	Refrigerant liquid line temperature sensor	10	Manometer
4	Refrigerant gas line temperature sensor	11	Pressure relief valve
5	Water outlet temperature sensor	12	Internal backup heater
6	Water inlet temperature sensor	13	Total outlet temperature sensor
7	Automatic air purge valve		

16125300A09888 V1.0



ES+FR+IT+PT



PL+TR+RU+RO



DE+NL

此页不做菲林，只做说明

材料：封面封底双胶纸120克，内页双胶纸80克

尺寸：大A4纸

颜色：黑白印刷，内容清晰

注意：超过60页使用胶装